



Suspension Catalogue



VOLUME 15

Ironman 4x4 warrants the original buyer, only when purchased new via authorised Ironman 4x4 resellers and distributors, from date of retail sale.

Product is warranted against defects in material or workmanship that cause the product to perform below the specified limits set by Ironman 4x4, to the extent that Ironman 4x4 will repair or replace any parts which are found to be defective.

All warranty claims must be submitted via original purchasing store or chain, unless otherwise arranged.

Proof of original purchase must be presented upon request.

Products may require to be returned to Ironman 4x4 for assessment or repair. Postage and removal costs involved are not the responsibility of Ironman 4x4, and may only be considered upon discretion by Ironman 4x4 in the event of such claim being verified.

The warranty does NOT apply where, 1) acts of neglect or misuse are evident, 2) product has been modified, 3) vehicles which are modified or not the recommended vehicle of use, 4) used in racing or competition conditions without the prior consent of Ironman 4x4, 5) used beyond the expectations of the original vehicle manufacturer.

Before installation of any product, please ensure you have received the correct parts for your application.

Ordering of the correct parts is the responsibility of the buyer. Return of a product in an un-used condition will attract a 15% restock fee, where Ironman 4x4 is not at fault.

Return of used or soiled product, 1) outside warranty period, 2) without fault, will result in refusal of your claim and be returned at buyer's expense.

SUSPENSION

All suspension products must undergo safety check at 500km after fitment. Fitment should be performed by an authorised or licensed mechanic, competent with suspension installations.

Special tools may be required when fitting some parts including struts. Damage to products through fitment error is not covered under warranty.

Warranty may become void when product is installed in conjunction with anything other than genuine manufacturer or Ironman components.

Where required, Ironman 4x4 recommend wheel alignment after fitment of any new suspension component. Obtaining wheel alignments is the responsibility of the buyer.

FREIGHT CONDITIONS

Freight of all products is the buyer's responsibility.

Where Ironman 4x4 have arranged freight, costs involved will be invoiced to the buyer.

Ironman 4x4 is not responsible for damage or loss during freight.

FITTING

All prices listed may be subject to fitting costs. The price of fitting is determined by the individual fitting agent.



SUSPENSION



LOAD PLUS



GENERAL INFORMATION

INSTALLATION	
Installation Times	2
Installation Form	3
PART SELECTION	
Spring Selection	4
Understanding Load	5
Shock Absorber Selection	6
APPLICATION GUIDES	
Shock Absorber Application Guide	8
Load Plus Application Guide	10
PRODUCT INFORMATION	
Features and Benefits	12

VEHICLE SUSPENSION

DACIA	
Duster 2010+	18
FORD	
Courier / Ranger 1985 - 2006	19
Ranger	
<i>PJ - PK 3/2006 - 2011</i>	20
<i>T6 PX 2011+</i>	21
HOLDEN / CHEVROLET / ISUZU	
Jackaroo	
<i>Isuzu Trooper Pre 1986</i>	22
<i>Isuzu Trooper 11/1986 - 1991</i>	23
<i>Isuzu Trooper / Bighorn / Monterey 1992+</i>	24
Frontera	
1995 - 1/1999	25
Rodeo	
<i>KB - TF 1991 - 1998</i>	26
<i>KB - TFS 1988 - 3/2003</i>	27
Rodeo / Colorado / D-Max	
<i>RA / RA7 / RC 2003 - 2012</i>	28
Colorado / D-Max	
<i>RG 2012+</i>	29
Colorado 7 / Trailblazer 2012+	30
MU-X 2013+	31
HYUNDAI	
Terracan 2001+	32
JEEP	
Cherokee	
<i>XJ 1984+</i>	33
<i>Liberty KJ 2001 - 2006</i>	38
<i>Liberty KK 2007 - 2012</i>	39
Wrangler	
<i>TJ 1996 - 2/2007</i>	34
<i>JK 2006+</i>	35
Grand Cherokee	
<i>ZJ/ZG 1993 - 1998</i>	36
<i>WJ/WG 1999 - 6/2005</i>	37
KIA	
Sorento BL 2003 - 2008	40
LADA	
Niva 1978+	41
LAND ROVER	
Defender	
<i>90 Series</i>	42
<i>110 Series Trayback</i>	43
<i>110, 130 Series County / Dual Cab</i>	44
Range Rover	
<i>(Coil Spring) 1971 - 1995</i>	45
Discovery	
<i>Series 1 1989 - 1998</i>	46
<i>Series 2 (Coil Spring) 1999 - 2005</i>	47
<i>Series 3 LR3 (Coil Spring) 2004 - 2009</i>	48
MAHINDRA	
Scorpio Getaway Pik-Up 2002+	49
Scorpio Wagon 2002+	50
MAZDA	
B Series	
<i>Bravo 1987 - 2006</i>	51
<i>BT50 2006 - 2011</i>	52
<i>BT50 2011+</i>	53

MERCEDES

G-Wagen	
<i>G55 AMG</i>	54
MITSUBISHI	
Triton	
<i>L200 Pre 1993</i>	55
<i>ME - MJ 1993 - 1996</i>	56
<i>MK 1996 - 2006</i>	57
<i>ML - MN 2005 - 2015</i>	58

Pajero	
<i>Montero NA - NG (Leaf) Pre 1991</i>	59
<i>Montero NH - NL (Leaf) 1991 - 1999</i>	60
<i>Montero NA - NG (Coil) 1988 - 1991</i>	61
<i>Montero NH - NL (Coil) 6/1991 - 2008</i>	62
<i>Montero NM - NW 2000+</i>	63
<i>iO Pinin 1999+</i>	67
Challenger	
<i>Montero Sport PA (Leaf) 1998 - 2006</i>	64
<i>Montero Sport PA (Coil) 1998 - 2008</i>	65
<i>Pajero Sport / Montero Sport / Dakar PB 2009+</i>	66

Delica	
<i>L400 1994+</i>	68

NISSAN

Patrol	
<i>MQ G160 (Round Headlights) Pre 1984</i>	69
<i>MK G160 (Rectangle Headlights) 1984+</i>	70
<i>GQ Y60 SWB 1988 - 1998</i>	72
<i>GQ Y60 LWB Wagon 1988 - 1998</i>	74
<i>GQ Y60 Cab Chassis (Leaf / Leaf) 1988+</i>	76
<i>GQ / GU Y61 Cab Chassis (Coil / Leaf)</i>	77
<i>GQ / GU Y61 Cab Chassis (Coil / Coil)</i>	78
<i>GU Y61 LWB Wagon</i>	80
<i>Y62 2009+</i>	82
Pathfinder / Terrano / II	
<i>R20 / WD21 Pre 1995</i>	83
Pathfinder	
<i>R50 1995+</i>	84
<i>R51 (4cyl Diesel and V6 Petrol) 7/2005+</i>	85
<i>R51 (V6 Diesel) 7/2005+</i>	86
Navara	
<i>D21 1985 - 1996</i>	87
<i>D22 / NP300 (Torsion Bar) 1997+</i>	88
<i>D40 (4Cyl Diesel and V6 Petrol) 2005+</i>	89
<i>D40 (V6 Diesel) 2005+</i>	90
<i>D23 NP300 2014+</i>	91

Paladin	
<i>Pre 2005</i>	92
Xterra	
2005+	93
Xtrail	
<i>T30 2001 - 9/2007</i>	94

RENAULT

Duster 2010+	95
--------------	----

SSANGYONG

Musso and Korando 1996+	96
-------------------------	----

SUZUKI

Sierra	
<i>Samurai LJ, SJ (Leaf) 1981+</i>	97
<i>SJ80 (Coil) 1997+</i>	98
Jimny	
<i>SN413 1998+</i>	99
Vitara	
1988+	100
Grand Vitara	
1988 - 7/2005	101
8/2005+	102

SUBARU

Forester SF5, GX, RX, GT 1997 - 2008	103
--------------------------------------	-----

TOYOTA

Hilux	
<i>Solid Front Axle 1979 - 10/1983</i>	104
<i>Solid Front Axle 11/1983 - 11/1997</i>	105
<i>IFS 107, 108, 110, 111, 167 1997 - 2005</i>	106
2WD 2005+	111
<i>Hilux / Vigo 2005+</i>	112

TOYOTA

4Runner	
<i>Gen 1, N60 (Leaf) 1988 - 1997</i>	107
<i>Gen 2, Surf N130 V6 (Coil) 1990 - 1997</i>	108
<i>Gen 3, N180 - N185 1996 - 2002</i>	109
<i>Gen 4 and 5, N210 - N280 2003+</i>	110
Landcruiser	
<i>40 Series 1960 - 1980</i>	114
<i>40, 42, 46 Series 1980 - 1984</i>	115
<i>45 Series 1960 - 1980</i>	116
<i>45, 47 Series 8/1980 - 1985</i>	117
<i>60 Series Pre 1986</i>	118
<i>60 Series 1986+</i>	120
<i>70, 73, 74 Series (Leaf / Leaf) 1984 - 1988</i>	122
<i>71 Series (Coil / Leaf)</i>	125
<i>75 Series 1984 - 1999</i>	126
<i>76 Series 2007+</i>	127
<i>78 Series 1999+</i>	128
<i>79 Series 1999+</i>	130
<i>79 Series Dual Cab 2013+</i>	132
<i>80 Series 1990+</i>	134
<i>100 Series IFS 1998+</i>	137
<i>105 Series 1998+</i>	138
<i>200 Series 2007+</i>	140

Bundera	
1984 - 1989	123

Landcruiser II	
<i>Prado 70, 73, 78 Series 1990 - 1996</i>	124

Prado	
<i>90, 95 Series</i>	141
<i>120 Series (Except Grande)</i>	142
<i>150 Series (Coil)</i>	143

FJ Cruiser	
2006+	144

Fortuner	
2004+	145

Tacoma	
2005+	146

Tundra	
2007+	147

TROLLER

T4	
1997 - 6/2014	148
7/2014+	149

UAZ

Hunter	150
Patriot 1997+	151

VOLKSWAGEN

Amarok 2010+	152
--------------	-----

PRODUCT SPECIFICATIONS

Coil Springs	153
Trim Packers	157
Leaf Springs	158
Torsion Bars	161
Shock Absorbers - Nitro Gas	162
Shock Absorbers - Foam Cell	165
Shock Absorbers - Foam Cell Pro	167
Steering Dampers	169
Shock Absorber Mount Type	170
U-Bolts	171
Load Plus	171
Polyurethane Suspension Arm Bush Kits	172
Rubber Suspension Arm Bushes	173

PRODUCT QUICK REFERENCE

PRODUCT CODE PAGE REFERENCE	174
------------------------------------	------------

TERMS AND CONDITIONS

CONDITIONS OF SALE	180
---------------------------	------------

RECOMMENDED INSTALLATION TIMES

Average installation times, based on one experienced fitter with all necessary tools and equipment

SUSPENSION KITS

COIL SPRING Front	LEAF SPRING Rear	3 Hours
STRUT Front	COIL SPRING Rear	3 Hours
STRUT Front	LEAF SPRING Rear	4 Hours
TORSION BAR Front	COIL SPRING Rear	3 Hours
TORSION BAR Front	LEAF SPRING Rear	4 Hours
COIL SPRING Front and Rear		2 Hours

LEAF SPRING Front and Rear	5 Hours
STRUT Front and Rear	4 Hours
LAND ROVER MODELS	3 Hours
VOLKSWAGEN AMAROK	5 Hours
MITSUBISHI PAJERO 2000 +	4 Hours
MITSUBISHI TRITON 2005 +	5 Hours

SUSPENSION COMPONENTS

COIL SPRINGS Pair	1 Hour
COIL SPRINGS Pair Independent Suspension	2 Hours
COIL SPRINGS Pair with Existing Airbags	2 Hours
LEAF SPRINGS Pair	2 Hours
LEAF SPRINGS Pair with Existing Airbags	2.5 Hours

TORSION BARS Pair	2 Hours
STRUT SHOCK ABSORBERS Pair	2 Hours
SHOCK ABSORBERS Pair	1 Hour
STEERING DAMPER	0.5 Hour
CASTER CORRECTION BUSHES	2 Hours

All times to be used as a guide only, times may vary depending on experience and equipment. Pre existing modifications or accessories may also increase installation times. Always allow extra time for unforeseen issues or stuck components.

Ironman 4x4 recommend a wheel alignment be performed within 1 week of installation, this allows time for the new suspension to settle, unless alignment is out of specification in which an immediate wheel alignment is recommended.

Always use Ironman 4x4 Suspension Installation Form to record ride height before and after, vehicle and owner details.



INSTALLATION FORM

Please copy and complete this form at the time of installation
Keep in a safe place for future reference

Always ensure you have all the correct parts before beginning installation.

Installing suspension often requires special tools and expert knowledge. All fitment should be performed by a qualified and experienced fitter. Always tighten bushed components after the vehicle is let down onto the ground at normal ride height, otherwise damage from torsional stresses can occur.

Brake proportioning valves should only be adjusted by a qualified brake specialist if necessary.

Ironman 4x4 recommends a wheel alignment after fitment of new suspension, consideration to natural spring settling should be taken into account before alignment is done. Always adhere to vehicle manufacturers torque specification when tightening fasteners.

Always grease polyurethane bushes prior to fitment, Ironman 4x4 recommends a molybdenum based grease or grease specified for polyurethane.

OWNER DETAILS

NAME: PHONE:

ADDRESS:

VEHICLE DETAILS

MAKE:MODEL:REG NO: ODOMETER:

ENGINE TYPE: BODY TYPE:

PRE EXISTING MODIFICATIONS OR WEIGHTED ACCESSORIES:

PART NUMBERS TO BE INSTALLED

PART # TYPE: PART # TYPE:

PART # TYPE: PART # TYPE:

PART # TYPE: PART # TYPE:

PART # TYPE: PART # TYPE:

PART # TYPE: PART # TYPE:

SUSPENSION MEASUREMENTS

VEHICLE HEIGHT
LOWER OF WHEEL RIM TO GUARD

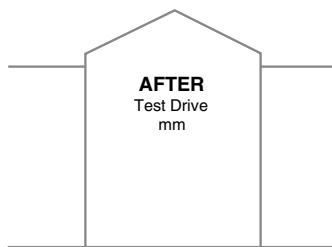
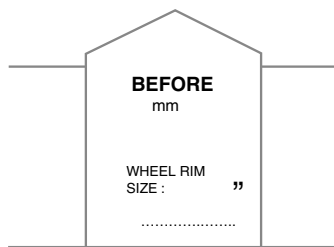

SUSPENSION MEASUREMENTS

ACTUAL MEASUREMENT OF NEW SPRINGS
PRIOR TO INSTALLATION

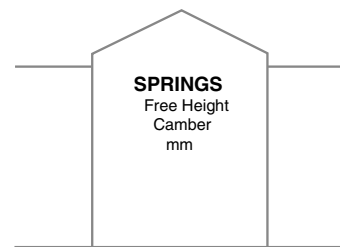

NOTES AND COMMENTS

NOTES:
.....
.....
.....
.....

All measurements to be taken prior to installation, immediately after initial test drive and again at 500km check.

All vehicle height measurements to be taken from lower of wheel rim to guard unless otherwise stated. Up to 10mm height reduction in springs can be considered normal settling over time. All measurements are metric except wheel rim size. Warranty period is 3 years or 60,000km unless otherwise stated.

SPRING SELECTION

Ironman 4x4 design and produce a range of coil and leaf springs to facilitate additional load and lift

PART NUMBER SUFFIX S - Standard Height (eg. TOY063S)

Available for selected applications to provide enhanced performance at original vehicle manufacturers ride height.

PART NUMBER SUFFIX A - Comfort (eg. TOY047A)

Suitable for zero to light load applications, higher priority toward comfort with minimal increased ride height.

PART NUMBER SUFFIX B - Performance (eg. TOY047B)

Suitable for use in zero to medium load applications, ideal for moderately accessorised vehicles or occasional load.

PART NUMBER SUFFIX C - Constant Load (eg. TOY047C)

Suitable for vehicles with permanent heavy accessories, higher priority towards load support, provides more control and firmer suspension.

PART NUMBER SUFFIX D - Extra Constant Load (eg. TOY047D)

Suited only to vehicles with permanent heavy accessories combined with heavy additional load.

PART NUMBER SUFFIX E - Extra Heavy Constant Load (eg. TOY047E)

Maximum support for extra heavy loads typically commercial or mining use vehicles.

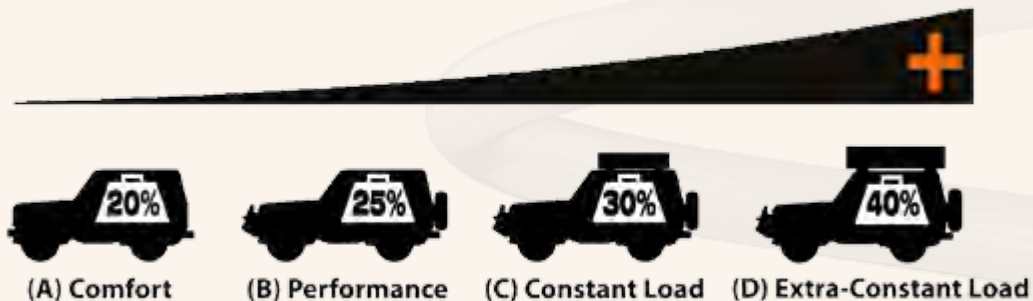

All lift heights quoted within this catalogue are general estimates only, relative to new vehicle ride height.

Suggested lifts are based upon the lighter of the recommended additional load. The position of added weight can affect the result.





Ironman 4x4 offer a wide range of springs and shock absorbers for each vehicle application. The correct selection of these components is most important in achieving the best suspension performance.

Each vehicle must be considered individually as many variables can influence the result.

Average weight of added accessories: To be referred to suggested additional load throughout catalogue.

BULL BAR Aluminium	+	40kg	WATER TANK 100 Litres	+	100kg
BULL BAR Steel	+	60kg	TRAY Aluminium	-	100kg
WINCH with Synthetic Rope	+	25kg	TRAY Steel	+	400kg
WINCH with Steel Cable	+	45kg	ROOF RACK	+	70kg
BATTERY Additional	+	25kg	ROOF TENT	+	60kg
DRAWER SYSTEM	+	80kg	FRIDGE 50 Litre	+	30kg
SPARE WHEEL Additional	+	50kg	TOOL BOXES	+	100kg
REAR WHEEL CARRIER Steel	+	65kg	LUGGAGE Additional	+	100kg - 300kg
FUEL TANK Extended Capacity	+	90kg	TOWING	+	100kg - 300kg

Consideration must be given to the added load and position of load in each case.

Understand the usage of the vehicle, select suspension appropriate to the type of conditions and workload, also consider the request and preference of the driver.

SHOCK ABSORBER SELECTION

Ironman 4x4 offer three ranges of shock absorbers

Each range is available in either soft comfort or firm valving

SOFT VALVING



Identified with part number suffix **GRC** or **FEC**.

Are best suited to lighter vehicles without load, higher priority towards a soft comfortable ride.

Delivers smooth handling and less harshness for everyday use.

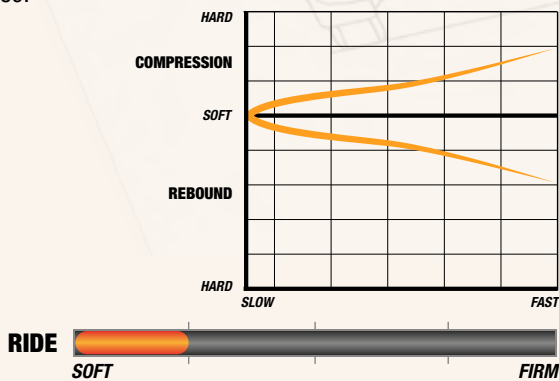

FIRM VALVING



Identified with part number suffix **GR** or **FE**.

Are best suited to heavier vehicles with more added accessories, higher priority towards control and stability.

Boosts performance and adapts to a wide range of driving styles.

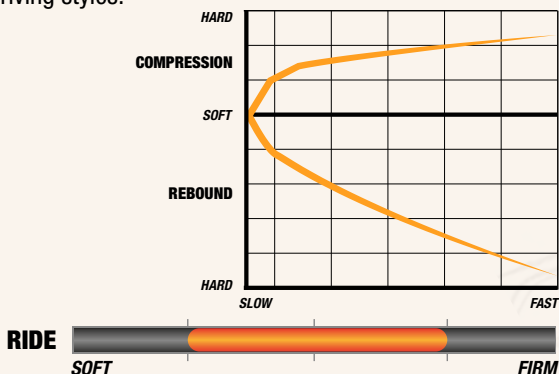

GRC
NITRO GAS COMFORT

GR
NITRO GAS

NITRO GAS SHOCK ABSORBER

Highly versatile performance upgrade from original shock absorbers.

- 35mm Piston
- 54mm Body
- 16mm Piston Rod
- Nitrogen Gas Pressurised
- Twin Tube Construction



SHOCK ABSORBER SELECTION

PART SELECTION



FEC
FOAM CELL COMFORT

FE
FOAM CELL

FOAM CELL SHOCK ABSORBER

Larger size and capacity suitable in all conditions.

- 40mm Piston
- 60mm Body
- 18mm Piston Rod
- Foam Cell Technology
- Twin Tube Construction



FEC^{PRO}
FOAM CELL PRO COMFORT

FE^{PRO}
FOAM CELL PRO

FOAM CELL PRO SHOCK ABSORBER

Maximum size and most robust design suitable in all conditions.

- 45mm Piston
- 65-72mm Body
- 20mm Piston Rod
- Foam Cell Technology
- Twin Tube Construction

Foam Cell and Foam Cell Pro shock absorbers may not be available for some models due to vehicle design limitations



Make	Model	Year	Nitro Gas		Foam Cell		Foam Cell Pro	
			Front	Rear	Front	Rear	Front	Rear
Dacia	Duster	2010+	12747GR	12748GR				
Ford	Courier / Ranger	1985 - 2011	12667GR	12095GR /C	24667FE	24095FE /C	45667FE	45095FE /C
Ford	Ranger T6 PX	2011+	12727GR	12095GR /C	24727FE	24095FE /C	45727FE	45095FE /C
Holden / Isuzu	Jackaroo / Trooper	Pre 1986	12087GR	12636GR /C	24087FE	24636FE /C		
Holden / Isuzu	Jackaroo / Trooper	11/1986 - 1991	12087GR	12671GR	24087FE			
Holden / Isuzu	Jackaroo / Trooper / Bighorn / Monterey	1992+	12643GR	12644GR	24643FE	24644FE		
Holden	Frontera	1995 - 1/1999	12667GR	12644GR	24667FE	24644FE		
Holden	Rodeo KB - TF	1991 - 1998	12087GR	12636GR /C	24087FE	24636FE /C		
Holden	Rodeo KB - TFS	1988 - 3/2003	12643GR	12636GR /C		24636FE /C		
Holden / Chevrolet / Isuzu	Rodeo / Colorado / D-Max / RA / RA7 / RC	2003 - 2012	12667GR	12636GR /C	24667FE	24636FE /C		
Holden / Isuzu	Colorado / D-Max / RG	2012+	12745GR	12636GR /C	24745FE	24636FE /C	45745FE	45636FE /C
Holden / Chevrolet	Colorado 7 / Trailblazer	2012+	12745GR	12746GR /C	24745FE	24746GR /C	45745FE	45746FE /C
Isuzu	MU-X	2013+	12745GR	12746GR /C	24745FE	24746GR /C	45745FE	45746FE /C
Hyundai	Terracan	2001+	12087GR	12637GR /C	24087FE			
Jeep	Cherokee XJ	1984+	12665GR	12666GR	24665FE	24666FE		
Jeep	Wrangler TJ	1996 - 2/2007	12665GR	12669GR	24665FE			
Jeep	Wrangler JK	2006+	12751GR	12752GR			45751FE	45752FE
Jeep	Wrangler JK 4" Lift	2006+	12751LGR	12752LGR				
Jeep	Grand Cherokee ZJ / ZG	1993 - 1998	12665GR	12670GR	24665FE			
Jeep	Grand Cherokee WJ / WG	1999 - 6/2005	12774GR	12775GR				
Jeep	Cherokee Liberty KJ / KK	2001 - 2012	12711GR	12712GR				
Land Rover	Defender 90 / 110 / 130 Series		12080GR	12640GR	24080FE	24640FE	45080FE	45640FE
Land Rover	Range Rover (Coil Spring)	1971 - 1995	12080GR	12640GR	24080FE	24640FE	45080FE	45640FE
Land Rover	Discovery Series 1	1989 - 1998	12080GR	12640GR	24080FE	24640FE	45080FE	45640FE
Land Rover	Discovery Series 2 (Coil Spring)	1999 - 2005	12776GR	12777GR	24776FE	24777FE		
Mahindra	Scorpio Pik-Up / Wagon	2002+	12087GR	12749GR				
Mazda	B Series / Bravo / BT50	1987 - 2011	12667GR	12095GR /C	24667FE	24095FE /C	45667FE	45095FE /C
Mazda	BT50	2011+	12727GR	12095GR /C	24727FE	24095FE /C	45727FE	45095FE /C
Mercedes	G-Wagen G55 AMG				24788FE	24789FE		
Mitsubishi	Triton L200 / ME-MJ	Pre 1996	12082GR	12636GR /C	24082FE	24636FE /C		
Mitsubishi	Triton MK	1996 - 2006	12087GR	12698GR /C	24087FE	24698FE /C		
Mitsubishi	Triton ML-MN	2005 - 2014	12715GR	12636GR /C	24715FE	24636FE /C		
Mitsubishi	Pajero / Montero NA-NL (Leaf)	Pre 1999	12082GR	12636GR /C	24082FE	24636FE /C		
Mitsubishi	Pajero / Montero NA-NG (Coil)	1988 - 1991	12082GR	12645GR /C	24082FE	24645FE /C		
Mitsubishi	Pajero / Montero NH-NL (Coil)	6/1991 - 2000	12087GR	12646GR	24087FE	24646FE		
Mitsubishi	Pajero / Montero NM-NW	2000+	12713GR	12714GR	24713FE			
Mitsubishi	Challenger / Montero Sport PA (Leaf)	1998 - 2006	12087GR	12636GR /C	24087FE	24636FE /C		
Mitsubishi	Challenger / Montero Sport PA (Coil)	1998 - 2008	12087GR	12645GR /C	24087FE	24645FE /C		
Mitsubishi	Challenger / Pajero Sport / Montero Sport / Dakar PB	2009+	12715GR	12645GR /C	24715FE	24645FE /C		
Mitsubishi	Delica L400 Without ECS	1994+	12667GR	12698GR	24667FE			
Mitsubishi	Delica L400 With ECS	1994+	12667GR	12671GR	24667FE			
Nissan	Patrol MQ / MK G160	Pre 1988	12075GR	12076GR				
Nissan	Patrol GQ / GU SWB & LWB Wagon		12091GR	12094GR	24091FE	24094FE	45091FE	45094FE
Nissan	Patrol GQ / GU SWB & LWB Wagon 4" Lift				24091LFE	24094LFE	45091LFE	45094LFE
Nissan	Patrol GQ / GU SWB & LWB Wagon 6" Lift				24091LFE1	24094LFE1	45091LFE1	45094LFE1
Nissan	Patrol GQ Y60 Cab Chassis (Leaf)		12661GR	12648GR	24661FE	24648FE		
Nissan	Patrol GU Y61 Cab Chassis (Leaf)		12091GR	12648GR	24091FE	24648FE		
Nissan	Patrol GU Y61 Cab Chassis (Coil)		12091GR	12094GR	24091FE	24094FE	45091FE	45094FE
Nissan	Patrol GU Y61 Cab Chassis (Coil) 4" Lift				24091LFE	24094LFE	45091LFE	45094LFE
Nissan	Patrol GU Y61 Cab Chassis (Coil) 6" Lift				24091LFE1	24094LFE1	45091LFE1	45094LFE1
Nissan	Patrol Y62	2009+	12740GR	12742GR	24740FE	24742FE	45740FE	45742FE
Nissan	Pathfinder / Terrano / II / R20 / WD21	Pre 1995	12667GR	12636GR /C	24667FE	24636FE /C		
Nissan	Pathfinder R51	7/2005+	12716GR	12718GR	24716FE	24718FE		
Nissan	Navara D21	1985 - 1996	12087GR	12636GR /C	24087FE	24636FE /C		



SHOCK ABSORBERS

APPLICATION GUIDES

Make	Model	Year	Nitro Gas		Foam Cell		Foam Cell Pro	
			Front	Rear	Front	Rear	Front	Rear
Nissan	Navara D22 / NP300 (Torsion Bar)	1997+	12791GR	12636GR /C				
Nissan	Navara D40	2005+	12716GR	12717GR	24716FE	24717FE	45716FE	45717FE
Nissan	Navara D23 / NP300	2014+	12716GR	12698GR /C	24716FE	24698FE /C	45716FE	45698FE /C
Nissan	Paladin	Pre 2005	12791GR	12698GR /C				
Nissan	Xterra	2005+	12716GR	12717GR	24716FE	24717FE	45716FE	45717FE
Renault	Duster	2010+	12747GR	12748GR				
Ssangyong	Musso / Korando	1996+	12667GR	12661GRS	24667FE	24661FES		
Suzuki	Sierra / Samurai LJ / SJ (Leaf)	1981+	12085GR	12086GR				
Suzuki	Jimny SN413	1998+	12759GR	12760GR				
Suzuki	Vitara SWB	1988+	12083GR	12089GR				
Suzuki	Vitara LWB	1988+	12083GR	12658GR				
Suzuki	Grand Vitara SWB	1988 - 7/2005	12083GR	12089GR				
Suzuki	Grand Vitara LWB	1988 - 7/2005	12083GR	12658GR				
Suzuki	Grand Vitara	8/2005+	12721GR	12722GR				
Toyota	Hilux Solid Front Axle	1979 - 10/1983	12639GR /C	12636GR /C	24639FE /C	24636FE /C		
Toyota	Hilux Solid Front Axle	11/1983 - 11/1997	12639GR /C	12650GR /C	24639FE /C	24650FE /C		
Toyota	Hilux / Tiger / 107 / 108 / 110 / 111 / 167	1997 - 2005	12088GR	12081GR /C	24088FE	24081FE /C		
Toyota	4Runner Gen 1, N60 Leaf	1988 - 1997	12088GR	12650GR /C	24088FE	24650FE /C		
Toyota	4Runner / Surf Gen 2, N130 V6 Coil	1990 - 1997	12088GR	12637GR /C	24088FE	24637FE /C		
Toyota	4Runner Gen 3, N180-N185	1996 - 2002	12691GR	12661GR	24691FE	24661FE	45691FE	45661FE
Toyota	4Runner Gen 4 & 5, N210-N280	2003+	12710GR	12682GRC	24710FE	24682FEC	45710FE	45682FEC
Toyota	Hilux 2WD	2005+	12764GR	12650GR /C		24650FE /C		45650FE /C
Toyota	Hilux / Vigo	2005+	12710GR	12650GR /C	24710FE	24650FE /C	45710FE	45650FE /C
Toyota	Hilux / Vigo Long Travel	2005+	12710GR	12081GR /C	24710FE	24081FE /C	45710FE	45081FE /C
Toyota	Landcruiser 40 / 42 / 45 / 46 / 47 Series	1960 - 1985	12635GR /C	12636GR /C	24635FE /C	24636FE /C	45635FE	45636FE /C
Toyota	Landcruiser 60 Series	Pre 1986	12637GR /C	12636GR /C	24637FE /C	24636FE /C	45637FE /C	45636FE /C
Toyota	Landcruiser 60 Series	1986+	12637GR /C	12650GR /C	24637FE /C	24650FE /C	45637FE /C	45650FE /C
Toyota	Landcruiser 70 / 73 / 74 Series (Leaf, Leaf)	1984 - 1988	12637GR /C	12650GR /C	24637FE /C	24650FE /C	45637FE /C	45650FE /C
Toyota	Bundera	1984 - 1989	12091GR	12639GRS ¹ 12650GR ²	24091FE	24639FES ¹ 24650FE ²		
Toyota	Landcruiser II / Prado 70 / 73 / 78 Series	1990 - 1996	12696GR	12697GR	24696FE	24697FE		
Toyota	Landcruiser 71 Series (Coil, Leaf)		12091GR	12081GR /C	24091FE	24081FE /C	45091FE	45081FE /C
Toyota	Landcruiser 75 Series	1984 - 1999	12637GR /C	12081GR /C	24637FE /C	24081FE /C	45637FE /C	45081FE /C
Toyota	Landcruiser 76 / 78 / 79 / 70 & D/Cab	2007+	12091GR	12094GR	24091FE	24094FE	45091FE	45094FE
Toyota	Landcruiser 76 / 78 / 79 / 70 & D/Cab Long Travel	2007+			24091FE	24094LFE	45091FE	45094LFE
Toyota	Landcruiser 80 / 105 Series	1990+	12683GR	12682GR	24683FE	24682FE	45683FE	45682FE
Toyota	Landcruiser 80 / 105 Series 4" Lift	1990+			24683LFE	24682LFE	45683LFE	45682LFE
Toyota	Landcruiser 80 / 105 Series 6" Lift	1990+			24683LFE1	24682LFE1	45683LFE1	45682LFE1
Toyota	Landcruiser 100 Series IFS	1998+	12795GR	12696GR	24795FE	24796FE	45795FE	45796FE
Toyota	Landcruiser 200 Series	2007+	12720GR	12796GR	24720FE	24796FE	45720FE	45796FE
Toyota	Prado 90 / 95 Series		12691GR	12661GR	24691FE	24661FE	45691FE	45661FE
Toyota	Prado 120 Series (except Grande)		12710GR	12682GRC	24710FE	24682FEC	45710FE	45682FEC
Toyota	Prado 150 Series (Coil)		12750GR	12682GRC	24750FE	24682FEC	45750FE	45682FEC
Toyota	FJ Cruiser	2006+	12710GR	12682GRC	24710FE	24682FEC	45710FE	45682FEC
Toyota	Fortuner	2004+	12710GR	12743GR /C	24710FE	24743FE /C	45710FE	45743FE /C
Toyota	Tacoma	2005+	12710GR	12744GR	24710FE	24744FE	45710FE	45744FE
Toyota	Tundra	2007+			24780FE	24781FE	45780FE*	45781FE
Troller	T4	1997 - 6/2014	12755GR	12755GR				
Troller	T4	7/2014+	12765GR	12765GR				
UAZ	Hunter		12652GR	12698GR	24652FE	24698FE		
UAZ	Patriot		12637GR	12698GR	24637FE	24698FE		
Volkswagen	Amarok	2010+	12725GR	12726GR				

/C Comfort Option Available

* 45780FE, Must Use Ironman Coil Springs TOY063B

¹ Bundera Left Hand Side ² Bundera Right Hand Side

Load+Plus

Helper Spring Kit



- ✓ **Maximise vehicle payload**
- ✓ **Improve safety and stability**
- ✓ **Reduce tyre, brake and suspension wear**
- ✓ **Reduce sway by up to 40%**
- ✓ **Reduce brake pitch by up to 20%**
- ✓ **Improve ride by up to 35%**
- ✓ **Reduce rear end sag by up to 20%**

CHRYSLER / DODGE / PLYMOUTH		Part No
B1500, B2500, B3500 - Vans	All	LP7
Caravan, T & C Van & Voyager	All	LP7
	All	LP4
D50 & Ram 50	All	LP4
D100, D150, D200 & D250	All	LP4
Dakota	All	LP4
Durango	All	LP4
R1500 & R2500	w/ 2.5" Leaf	LP4
R1500 & R2500	w/ 3.0" Leaf	LP7
Raider	All	LP4
Ramcharger & Trailduster	All	LP4
W100, W150, W200 & W250	All	LP4
DAIHATSU		
Feroza F300, F310	88-99	LP1
Feroza II	All	LP4
Rocky	All	LP1
FORD / LINCOLN / MERCURY		
Bronco	w/ 2.5" Leaf	LP4
	w/ 3.0" Leaf	LP7
Bronco II	w/ 2.5" Leaf	LP4
	w/ 3.0" Leaf	LP7
Courier / Ranger (Not USA model)	All	LP3
Econovan & Spectron	All	LP1
E Series Vans	w/ 2.5" Leaf	LP4
	w/ 3.0" Leaf	LP7
Excursion	All	LP7
Explorer	w/ Leaf	LP4
Falcon Sedan XR-XD	All	LP4
Falcon Panel Van XR-XH	All	LP4
Falcon Utility 1 Tonne XR - On	All	LP4
F Series	w/ 2.5" Leaf	LP4
	w/ 3.0" Leaf	LP7
Mountainer & Aviator	All	LP4
Ranger (USA model only)	All	LP4
<i>* Not suitable Falcon wagon, except dedicated LPG</i>		
GENERAL MOTORS / CHEVROLET / HOLDEN		
Commodore 1 Tonne	All	LP1
Jackaroo	All	LP3
Rodeo / Colorado / D-Max*	81-03	LP3
Shuttle	All	LP3
Utility and Van HQ-WB	All	LP4
Astro & Safari Van	w/ Leaf	LP4
C, K, R & V Series 1/2 & 3/4 Ton	w/ 2.5" Leaf	LP4
	w/ 3.0" Leaf	LP7
Denali & Escalade	All	LP7
G Series, Express 1/2, 3/4 & 1 Ton	w/ 2.5" Leaf	LP4
	w/ 3.0" Leaf	LP7
Savannah Vans 1/2, 3/4 & 1 Ton	w/ 2.5" Leaf	LP4
	w/ 3.0" Leaf	LP7
LUV	All	LP3
S10 Blazer & T10	All	LP4
S15 Jimmy, T15 & Sonoma	All	LP4
Suburban 1/2, 3/4 Ton	w/ 2.5" Leaf	LP4
	w/ 3.0" Leaf	LP7
Tahoe & Yukon	w/ 2.5" Leaf	LP4
	w/ 3.0" Leaf	LP7
Silverado	All	LP7
<i>*Not suitable for Rodeo / Colorado / D-Max 2003+ Models with interleaf liners</i>		
HONDA		
Passport	w/ Leaf	LP3
INTERNATIONAL		
Scout	All	LP3

ISUZU		Part No
Amigo	All	LP3
Hombre	All	LP3
Pickup, P'up	All	LP3
Rodeo	w/ Leaf	LP3
Trooper II	w/ Leaf	LP3
JEEP		
Cherokee & Wagoneer	All	LP4
CJ5, CJ6 & CJ7	All	LP4
Commanche Pickup	All	LP4
Gladiator Pickup	All	LP4
J10 & J20 Series	All	LP4
Wrangler YJ	All	LP4
KIA		
Pregio*	All	LP4
<i>* Not suitable for Kia vehicles with tow bar fitted</i>		
MAZDA		
Navaho	All	LP4
Pickups	All	LP3
Bravo / BT50	All	LP3
B1800 / B2000 4x2	All	LP3
B2200 / B2600 4x2, 4x4	All	LP1
E1400	All	LP1
E1800	All	LP1
E2000	All	LP1
E2200	All	LP1
MERCEDES		
MB100	99-02	LP4
MB140	99-02	LP4
Sprinter	98 On	LP4
MITSUBISHI		
Pickup	All	LP4
Pajero / Montero	w/ Leaf	LP4
Triton 4x2, 4x4	All	LP4
L200 / L300 Van	All	LP4
Starwagon / Express Van	All	LP4
NISSAN		
Frontier	All	LP2
X-Terra	All	LP2
Titan	All	LP2
Navara D21, D22	All	LP3
Navara D40	All	LP2
Navara D23	All	LP2
Urvan	All	LP3
Patrol GQ / GU Cab / Chassis	All	LP4
Patrol MQ / MK, G160, Y260	All	LP3
SUZUKI		
Sierra / Samurai	All	LP5
TOYOTA		
Pickups	All	LP2
T100	All	LP4
Tundra	w/ 2.5" Leaf	LP4
	w/ 3.0" Leaf	LP7
Hiace	All	LP3
Hilux / 4Runner	All	LP2
Landcruiser FJ40 / BJ40-42	60-84	LP4
Landcruiser FJ / HJ60 / 61 / 62	80-90	LP4
Landcruiser HJ / HZJ 75*	84-99	LP4
Landcruiser HZJ 78 / 79*	All	LP9
Landcruiser 76*	All	LP4
Tacoma	All	LP2
Townace	All	LP1
<i>* Landcruiser drum brake rear models only</i>		
VOLKSWAGEN		
Amarok	All	LP4



NITRO GAS SHOCK ABSORBERS

Gas Pressurised shock absorber boosts performance and adapts to a wide range of driving styles

NITROGEN GAS PRESSURISED - Low pressure nitrogen gas dramatically reduces the likelihood of oil aeration and shock fade.

35mm TEFLON BANDED PISTON - Precision shim-stack piston specifically valved by Ironman suspension engineers, banded with teflon for smooth long life operation.

54mm TWIN TUBE BODY - Increased oil volume for improved cooling and endurance, Twin tube construction protects internal components from rock damage.

16mm – 18mm HARD CHROME PISTON ROD - Hardened and polished, volumetrically balanced to piston size.

FLEXIBLE RUBBER BUSHES - Offers quieter operation and reduces damaging side loads from shock absorber.

TRIPLE-LIP HIGH PRESSURE NOK SEAL - Maximum gas and oil retention ability to withstand high displacement offroad use.

SUPPLEMENTARY WELDED MOUNTS - Fusion welded and supplementary welded for maximum strength and reliability.

SINGLE PIECE BILLET EYE RINGS AND STEMS - Ultra robust design prevents breakage or bending of mounts.

VEHICLE SPECIFIC VALVING - Every part number is specially valved for each vehicle application, this ensures the best possible ride and handling as intended by Ironman suspension engineers.

LONG TRAVEL - Suitable for standard and raised height vehicles, additional length increases wheel articulation.

IMPACT RESISTANT STONE SHIELD - Steel or Polyethylene dust shield protects piston rod from impacts and road debris.



FOAM CELL SHOCK ABSORBERS

Premium shock absorber for superior endurance in all conditions

FOAM CELL TECHNOLOGY - Micro-Cellular closed cell foam insert maximises cooling efficiency by occupying less internal space than gas within a pressurised shock absorber. Greater oil capacity and more surface area maintains lower operating temperatures.

40-45mm TEFLON BANDED PISTON - Precision shim-stack piston specifically valved by Ironman suspension engineers, banded with teflon for smooth long life operation.

60-72mm TWIN TUBE BODY - 50%-100% more oil volume than a gas shock absorber for superior cooling and endurance. Twin tube construction protects internal components from rock damage.

18-20mm HARD CHROME PISTON ROD - Hardened and polished, volumetrically balanced to piston size.

FLEXIBLE RUBBER BUSHES - Offers quieter operation and reduces damaging side loads from shock absorber.

TRIPLE-LIP HIGH PRESSURE NOK SEAL - Maximum oil retention ability to withstand high displacement offroad use.

SUPPLEMENTARY WELDED MOUNTS - Fusion welded then supplementary welded for higher strength and reliability.

360° WELDED MOUNTS - Fusion welded then fully welded around mounting for maximum strength and reliability.

SINGLE PIECE BILLET EYE RINGS AND STEMS - Ultra robust design prevents breakage or bending of mounts.

VEHICLE SPECIFIC VALVING - Every part number is specially valved for each vehicle application, this ensures the best possible ride and handling as intended by Ironman suspension engineers.

LONG TRAVEL - Suitable for standard and raised height vehicles, additional length increases wheel articulation.

IMPACT RESISTANT STONE SHIELD - Steel or Polyethylene dust shield protects piston rod from impacts and road debris.





COIL SPRINGS

Available in a wide range of load ratings to maintain optimum ride height

COLD COILED - CNC cold coiling ensures perfect consistency and accuracy, less heat during manufacture maintains material properties resulting in longer life.

BAR PEELED - Bar peeling is the process of machining the material to an exact size before coiling, this ensures the diameter remains constant and free of flaws along its entire length.

SHOT PEENED - Manipulates material surface tension to reduce stress, greatly enhances spring life.

TRIPLE SCRAGGED - Each coil is fully compressed to a solid state 3 times to minimise coil settling.

PROGRESSIVE AND LINEAR RATE - Used in accordance to original vehicle manufacturers preference, progressive springs increase rate as the spring compresses, linear springs maintain a consistent rate throughout its range.

POWDERCOATED - All springs are electro-static powdercoated for a durable finish.



LEAF SPRINGS

Available in a wide range of load ratings to maintain optimum ride height

INTER LEAF LINERS - Used in some applications to lower friction between leaves reducing noise and improving comfort.

LINED BOLT CLAMPS - All Ironman springs feature bolted guide clamps for greater flex, the addition of anti-friction liners ensures noise free smooth operation.

SHOT PEENED - Manipulates tension side of material to reduce stress, greatly enhances spring life.

DIAMOND CUT LEAVES - Distributes load at the leaf tip and reduces interleaf friction.

MILITARY WRAP - Where applicable, an additional wrap around the leaf eye protects from failure in case of damage.



TORSION BARS

Higher spring rate to support extra weight from additional vehicle accessories

UP-SET FORGED ENDS - Stronger than machining alone, forging manipulates steel grain for superior strength and durability.

PREMIUM MICRO-ALLOY STEEL - Exceeds OEM steel grade for ultra long life and less sag.

INCREASED BAR DIAMETER - Higher spring rate better supports added accessories and balances front and rear suspension performance.

X-RAY EXAMINED - Each and every Ironman Torsion Bar is X-Ray tested to eliminate risk of breakage due to material flaw.

DIRECTIONAL PRE-SETTING - Torsion Bars are rotationally pre-set in their direction of installation to reduce spring settling. Each bar is marked for left or right fitment.



FEATURES AND BENEFITS



POLYURETHANE BUSHES

Provide precise spring location and enables lubrication to increase suspension flex and comfort

INJECTION MOULDED POLYURETHANE - High density injection moulded polyurethane material ensures precise location and a durable bearing surface for your leaf springs, making them very durable in hot temperatures whilst providing a soft comfortable vehicle ride.

GREASABLE - Polyurethane bushes are greasable to aid in longer life and ensure smooth ride and quiet operation.

SPIRAL BORE AND FLANGES - To distribute lubricating grease evenly throughout the bushing surface when combined with greasable shackles and pins.

SPLINES - Allows the bush to conform to irregularities and grip to the eye surface.



GREASABLE SHACKLES AND PINS

Enables easy re-greasing of polyurethane spring bushes

QUAD-OUTLET GREASABLE - Greasable shackles provide an easy method of re-lubricating polyurethane bushes. Chamfered Quad-Outlet ports distribute grease liberally along the bush surface.

SERVICEABLE - All Ironman shackles and pins feature a serviceable bolt together construction.

ANTI-INVERSION SHACKLE - On selected models, a third pin is positioned on the shackle to protect the spring in the case of inversion.



STEERING DAMPER

Reduce unwanted vibration and feedback through steering system in rough conditions

FOAM CELL TECHNOLOGY - Micro-Cellular closed cell foam insert allows for the horizontal mounting orientation required by a steering damper.

35mm TEFLON BANDED PISTON - Precision shim-stack piston specifically valved by Ironman suspension engineers, banded with Teflon for smooth long life operation.

54mm TWIN TUBE BODY - Increased oil volume for improved cooling and endurance, twin tube construction protects internal components from impact damage.

SUPPLEMENTARY WELDED MOUNTS - Fusion welded and supplementary welded for maximum strength and reliability.

SINGLE PIECE BILLET EYE RINGS AND STEMS - Ultra robust design prevents breakage or bending of mounts.

VEHICLE SPECIFIC VALVING - Every part number is specially valved for each vehicle application, this ensures the steering operation is smooth and unhindered by the effects of rough road driving.



CASTER CORRECTION BUSHES

Available in adjustable or fixed offset designs, used to correct caster angle after raising suspension under 100mm (4")

PRE-CONFIGURED CASTER CORRECTION - Fixed 2 degree offset models suit 50mm (2") lifted suspension.

ADJUSTABLE CASTER CORRECTION - Adjustable offset suit a wide range of lift heights up to 100mm (4")

HIGH DENSITY MATERIALS - Vehicle specific rubber or polyurethane material.





CASTER CORRECTION PLATES

Used to correct caster angle after raising suspension beyond 100mm (4")

PRE-CONFIGURED CASTER CORRECTION - Fixed 5 degree offset models suit 100mm (4") to 150mm (6") lifted suspension.



ADJUSTABLE PANHARD RODS

Used to correct axle shift after raising suspension. Adjustable as required to re-centralise axle to vehicle

COMPETITION SPEC - 32mm solid rod used throughout.

FINE THREAD ADJUSTMENT - M32 x 2mm thread ensures precision adjustment for greater accuracy.

OEM STYLE RUBBER BUSHES - Maximum flex and durability. Replaceable OEM compatible bushes.



EXTENDED SWAY BAR LINKS

Recalibrates sway bar index after raising suspension.

VEHICLE SPECIFIC BOLT ON DESIGN - Easy fitment, utilises OEM mounting locations.

ADJUSTABLE LENGTH - Adjustable extension where possible depending on vehicle model.

PRACTICAL DESIGN - Strongest construction up-spec materials to avoid bending and breaking. Rubber bushes and aircraft grade spherical bearings used where possible depending on vehicle model.



POLYURETHANE COIL SPRING SPACERS / TRIM PACKERS

Available individually to adjust "side to side" or "front to back" vehicle lean due to uneven load placement

INJECTION MOULDED POLYURETHANE - High density injection moulded polyurethane material ensures precise location and a durable seat with the spring.

PRE-CONFIGURED THICKNESSES - Varied thicknesses allow correct selection according to the amount of lean. Provides 1:1 ratio suspension lift on solid axle vehicles.

SELF LOCATING DESIGN - Raised profile locating flanges prevent packer from becoming dislodged or falling out.

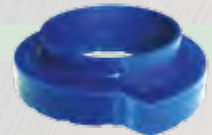

STRUT TRIM PACKERS

For use only with Ironman 4x4 struts, available individually to adjust "side to side" or "front to back" vehicle lean due to uneven load placement.

PRECISE RIDE HEIGHT TUNING - Basic steel collar design fits over Ironman 4x4 struts to adjust spring seat height.

PRE-CONFIGURED THICKNESSES - Varied thicknesses allow correct selection according to the amount of adjustment required. Usually provides 1:2 ratio suspension lift on independent suspension vehicles.



FEATURES AND BENEFITS



EXTENDED BRAKE HOSES



Longer brake hose used with suspension lifts over 100m (4").

DOT SAE J1401 STANDARDS APPROVED CONSTRUCTION - OEM style reinforced rubber hose for safety.

EXTENDED LENGTH - Extended length allows for greater suspension travel.

ADJUSTABLE TRAILING ARMS



Used to correct rear axle tilt and location after raising suspension.

COMPETITION SPEC - 32mm solid rod used throughout.

FINE THREAD ON-VEHICLE ADJUSTMENT - M32 x 2mm thread ensures precision adjustment for greater accuracy.

OEM STYLE RUBBER BUSHES - Maximum flex and durability. Replaceable OEM compatible bushes.

ADJUSTABLE DRAG LINKS



Adjustable length rod to centralise steering wheel after suspension lift.

ADJUSTABLE LENGTH - Compatible with all suspension ride heights.

STRONGER CONSTRUCTION - Reduces likelihood of failure due to impact.

BOLT ON STEERING DAMPER MOUNTS - Steering damper mounts can be positioned freely as required to suit suspension lift.



SUSPENSION KITS

Fully integrated suspension kits containing all required components to achieve a safe and balanced suspension performance.

ALL LEAF SPRING KITS CONTAIN: Springs, Shock Absorbers, Ubolts and Bushes.

ALL COIL SPRING KITS CONTAIN: Springs and Shock Absorbers.

Ironman 4x4 also offer various optional components further enhancing suspension performance or geometry correction purposes, see vehicle listings for model specific details.

Such components include Greasable Shackles & Pins, Steering Damper, Caster Correction, Trim Packers, Suspension Arms.



LEAF / LEAF (LL) SUSPENSION KIT



STRUT / LEAF (SL) SUSPENSION KIT



COIL / COIL (CC) SUSPENSION KIT



STRUT / COIL (SC) SUSPENSION KIT



TORSION BAR / LEAF (TL) SUSPENSION KIT



TORSION BAR / COIL (TC) SUSPENSION KIT



Product	Part No.	Qty Req
---------	----------	---------

FRONT SUSPENSION

SHOCK ABSORBER

Nitro Gas Strut	12747GR	2
-----------------	----------------	---

COIL SPRINGS

Estimated Lift	Additional Load
----------------	-----------------

Performance	40mm	0 - 50kg	REN001B	1
-------------	------	----------	----------------	---

CAMBER CORRECTION

Camber Bolt Kit	ICAMBER12	1
-----------------	------------------	---

REAR SUSPENSION

SHOCK ABSORBER

Nitro Gas Strut	12748GR	2
-----------------	----------------	---

COIL SPRINGS

Estimated Lift	Additional Load
----------------	-----------------

Performance	40mm	0 - 200kg	REN002B	1
-------------	------	-----------	----------------	---

CAMBER CORRECTION

Camber Bolt Kit	ICAMBER12	1
-----------------	------------------	---

SUSPENSION KIT

Performance w/ Gas Shocks	REN001BKG
---------------------------	------------------

SUSPENSION KIT CONTENTS

Strut Shock Absorbers	Camber Bolt Kits
Coil Springs	



Product

Part No.

Qty Req

FRONT SUSPENSION

SHOCK ABSORBER

Nitro Gas	12667GR	2
Foam Cell	24667FE	2
Foam Cell Pro	45667FE	2

TORSION BAR

Up-rated Torsion Bars	MAZDA005	1
-----------------------	-----------------	---

• Minimum 60mm downward suspension travel required

REAR SUSPENSION

SHOCK ABSORBER

Nitro Gas Comfort	12095GRC	2
Nitro Gas	12095GR	2
Foam Cell Comfort	24095FEC	2
Foam Cell	24095FE	2
Foam Cell Pro Comfort	45095FEC	2
Foam Cell Pro	45095FE	2

LEAF SPRING

Estimated Lift

Additional Load

	Estimated Lift	Additional Load		
Comfort	40mm	0 - 100kg	MAZDA006A	2
Performance	40mm	0 - 200kg	MAZDA006B	2
Constant Load	40mm	200 - 400kg	MAZDA006C	2
Extra Constant Load	40mm	400kg - GVM	MAZDA006D	2

U-BOLTS

U-Bolt Kit	415UBK	2
------------	---------------	---

POLYURETHANE SPRING BUSHES

Bush Kit	756UK	1
----------	--------------	---

GREASABLE SHACKLES AND PINS

Greasable Shackle	386-1	2
Greasable Pin	794	2

LOAD PLUS

Load Plus Helper Springs	LP3	1
--------------------------	------------	---

SUSPENSION KIT

Comfort w/ Gas Shocks	MAZDA006AKG
Comfort w/ Foam Cell Shocks	MAZDA006AKF
Comfort w/ Foam Cell Pro Shocks	MAZDA006AKP
Performance w/ Gas Shocks	MAZDA006BKG
Performance w/ Foam Cell Shocks	MAZDA006BKF
Performance w/ Foam Cell Pro Shocks	MAZDA006BKP
Constant Load w/ Gas Shocks	MAZDA006CKG
Constant Load w/ Foam Cell Shocks	MAZDA006CKF
Constant Load w/ Foam Cell Pro Shocks	MAZDA006CKP
Extra Constant Load w/ Gas Shocks	MAZDA006DKG
Extra Constant Load w/ Foam Cell Shocks	MAZDA006DKF
Extra Constant Load w/ Foam Cell Pro Shocks	MAZDA006DKP

SUSPENSION KIT CONTENTS

Shock Absorbers	U-Bolts
Leaf Springs	Polyurethane Spring Bushes
Torsion Bars	

RANGER

PJ - PK (Not USA Model)
3/2006 - 2011



Product **Part No.** **Qty Req**

FRONT SUSPENSION

SHOCK ABSORBER

Nitro Gas		12667GR	2
Foam Cell		24667FE	2
Foam Cell Pro		45667FE	2

TORSION BAR

Uprated Torsion Bars	Duratorq Engine	MAZDA014	1
Uprated Torsion Bars	2.5L WLT Engine	MAZDA005	1

- MAZDA014 is 1024mm in length, used on most vehicles. Vehicles with 2.5L WLT Engine use MAZDA005 (924mm) Torsion Bar
- Minimum 60mm downward suspension travel required

REAR SUSPENSION

SHOCK ABSORBER

Nitro Gas Comfort		12095GRC	2
Nitro Gas		12095GR	2
Foam Cell Comfort		24095FEC	2
Foam Cell		24095FE	2
Foam Cell Pro Comfort		45095FEC	2
Foam Cell Pro		45095FE	2

LEAF SPRING	Estimated Lift	Additional Load		
Comfort	40mm	0 - 100kg	MAZDA041A	2
Performance	40mm	0 - 200kg	MAZDA041B	2
Constant Load	40mm	200 - 400kg	MAZDA041C	2
Extra Constant Load	40mm	400kg - GVM	MAZDA041D	2

U-BOLTS

U-Bolt Kit	417UBK	2
------------	---------------	---

POLYURETHANE SPRING BUSHES

Bush Kit	759UK	1
----------	--------------	---

GREASABLE SHACKLES AND PINS

Greasable Shackle	386-1	2
-------------------	--------------	---

LOAD PLUS

Load Plus Helper Springs	LP3	1
--------------------------	------------	---

SUSPENSION KIT

Comfort w/ Gas Shocks	MAZDA041AKG
Comfort w/ Foam Cell Shocks	MAZDA041AKF
Comfort w/ Foam Cell Pro Shocks	MAZDA041AKP
Performance w/ Gas Shocks	MAZDA041BKG
Performance w/ Foam Cell Shocks	MAZDA041BKF
Performance w/ Foam Cell Pro Shocks	MAZDA041BKP
Constant Load w/ Gas Shocks	MAZDA041CKG
Constant Load w/ Foam Cell Shocks	MAZDA041CKF
Constant Load w/ Foam Cell Pro Shocks	MAZDA041CKP
Extra Constant Load w/ Gas Shocks	MAZDA041DKG
Extra Constant Load w/ Foam Cell Shocks	MAZDA041DKF
Extra Constant Load w/ Foam Cell Pro Shocks	MAZDA041DKP

SUSPENSION KIT CONTENTS

Shock Absorbers	U-Bolts
Leaf Springs	Polyurethane Spring Bushes
Torsion Bars	



Product

Part No.

Qty Req

FRONT SUSPENSION

SHOCK ABSORBER

Nitro Gas Strut			12727GR	2
Foam Cell Strut			24727FE	2
Foam Cell Pro Strut			45727FE	2

• Height adjustable with Ironman 4x4 Strut Trim Packers

COIL SPRINGS

	Estimated Lift	Additional Load		
Standard	0mm	0 - 50kg	FOR001S	1
Comfort	35mm	0 - 50kg	FOR001A	1
Performance	40mm	0 - 50kg	FOR001B	1
Constant Load	45mm	50 - 110kg	FOR001C	1

TRIM PACKERS

5mm Strut Trim Packer	(Nitro Gas / Foam Cell)	HILFR05 / HILFR05F	2
10mm Strut Trim Packer	(Nitro Gas / Foam Cell)	HILFR10 / HILFR10F	2
15mm Strut Trim Packer	(Nitro Gas / Foam Cell)	HILFR15 / HILFR15F	2

• ONLY Compatible with Ironman 4x4 Struts (except Pro), lift height subject to 1:2 motion ratio. Unnecessary fitment may lift vehicle too high

REAR SUSPENSION

SHOCK ABSORBER

Nitro Gas Comfort			12095GRC	2
Nitro Gas			12095GR	2
Foam Cell Comfort			24095FEC	2
Foam Cell			24095FE	2
Foam Cell Pro Comfort			45095FEC	2
Foam Cell Pro			45095FE	2

LEAF SPRING

	Estimated Lift	Additional Load		
Comfort	40mm	0 - 200kg	FOR002A	2
Performance	45mm	0 - 300kg	FOR002B	2
Constant Load	45mm	300kg - GVM	FOR002C	2

U-BOLTS

U-Bolt Kit			417UBK	2
------------	--	--	---------------	---

POLYURETHANE SPRING BUSHES

Bush Kit			1193UK	1
----------	--	--	---------------	---

DRIVELINE SPACERS

Centre Bearing Spacer Kit			1194K	1
---------------------------	--	--	--------------	---

GREASABLE SHACKLES AND PINS

Greasable Shackle			1147	2
Non-Greasable Pin			387-1	2

LOAD PLUS

Load Plus Helper Springs			LP3	1
--------------------------	--	--	------------	---

SUSPENSION KIT

Comfort w/ Gas Shocks	FOR001AKG
Comfort w/ Foam Cell Shocks	FOR001AKF
Comfort w/ Foam Cell Pro Shocks	FOR001AKP
Performance w/ Gas Shocks	FOR001BKG
Performance w/ Foam Cell Shocks	FOR001BKF
Performance w/ Foam Cell Pro Shocks	FOR001BKP
Constant Load w/ Gas Shocks	FOR001CKG
Constant Load w/ Foam Cell Shocks	FOR001CKF
Constant Load w/ Foam Cell Pro Shocks	FOR001CKP

• Specify front coil springs when ordering

SUSPENSION KIT CONTENTS

Shock Absorbers	Leaf Springs	Centre Bearing Spacer Kit
Strut Shock Absorbers	U-Bolts	
Coil Springs	Polyurethane Spring Bushes	

JACKAROO

Isuzu Trooper
Pre 1986



Product	Part No.	Qty Req
---------	----------	---------

FRONT SUSPENSION

SHOCK ABSORBER

Nitro Gas	12087GR	2
Foam Cell	24087FE	2

TORSION BAR

Upated Torsion Bars	MAZDA005	1
---------------------	----------	---

• Minimum 60mm downward suspension travel required

REAR SUSPENSION

SHOCK ABSORBER

Nitro Gas Comfort	12636GRC	2
Nitro Gas	12636GR	2
Foam Cell Comfort	24636FEC	2
Foam Cell	24636FE	2

LEAF SPRING	Estimated Lift	Additional Load		
Performance Drivers Side	40mm	0 - 300kg	HOLD004BD/S	1
Performance Near Side	40mm	0 - 300kg	HOLD004BN/S	1
Constant Load Drivers Side	40mm	300kg - GVM	HOLD004CD/S	1
Constant Load Near Side	40mm	300kg - GVM	HOLD004CN/S	1

U-BOLTS

U-Bolt Kit	451UBK	2
------------	--------	---

POLYURETHANE SPRING BUSHES

Bush Kit	747UK	1
----------	-------	---

GREASABLE SHACKLES AND PINS

Greasable Shackle	791	2
Greasable Pin	792	2

LOAD PLUS

Load Plus Helper Springs	LP3	1
--------------------------	-----	---

SUSPENSION KIT

Performance w/ Gas Shocks	HOLD005BKG
Performance w/ Foam Cell Shocks	HOLD005BKF
Constant Load w/ Gas Shocks	HOLD005CKG
Constant Load w/ Foam Cell Shocks	HOLD005CKF

SUSPENSION KIT CONTENTS

Shock Absorbers	U-Bolts
Leaf Springs	Polyurethane Spring Bushes
Torsion Bars	



Product	Part No.	Qty Req
---------	----------	---------

FRONT SUSPENSION

SHOCK ABSORBER

Nitro Gas	12087GR	2
Foam Cell	24087FE	2

TORSION BAR

Uprated Torsion Bars	33mm Spline	HOLD005A	1
Uprated Torsion Bars	36mm Spline	HOLD007	1

• Minimum 60mm downward suspension travel required

REAR SUSPENSION

SHOCK ABSORBER

Nitro Gas	12671GR	2
-----------	----------------	---

LEAF SPRING

	Estimated Lift	Additional Load		
Performance Drivers Side	40mm	0 - 300kg	HOLD004BD/S	1
Performance Near Side	40mm	0 - 300kg	HOLD004BN/S	1
Constant Load Drivers Side	40mm	300kg - GVM	HOLD004CD/S	1
Constant Load Near Side	40mm	300kg - GVM	HOLD004CN/S	1

U-BOLTS

U-Bolt Kit	451UBK	2
------------	---------------	---

POLYURETHANE SPRING BUSHES

Bush Kit	747UK	1
----------	--------------	---

GREASABLE SHACKLES AND PINS

Greasable Shackle	791	2
Greasable Pin	792	2

LOAD PLUS

Load Plus Helper Springs	LP3	1
--------------------------	------------	---

SUSPENSION KIT

Performance w/ Gas Shocks	HOLD007BKG
Performance w/ Foam Cell Shocks	HOLD007BKF

SUSPENSION KIT CONTENTS

Shock Absorbers	U-Bolts
Leaf Springs	Polyurethane Spring Bushes
Torsion Bars	

JACKAROO

Isuzu Trooper / Bighorn / Monterey
1992+



Product	Part No.	Qty Req
---------	----------	---------

FRONT SUSPENSION

SHOCK ABSORBER

Nitro Gas	12643GR	2
Foam Cell	24643FE	2

TORSION BAR

Up-rated Torsion Bars	HOLD009	1
-----------------------	---------	---

• Minimum 60mm downward suspension travel required

REAR SUSPENSION

SHOCK ABSORBER

Nitro Gas	12644GR	2
Foam Cell	24644FE	2

COIL SPRINGS

	Estimated Lift	Additional Load		
Performance	40mm	0 - 300kg	HOLD008B	1
Constant Load	40mm	300kg - GVM	HOLD008C	1

• Use HOLD008C for 3/2001+ Models

SUSPENSION KIT

Performance w/ Gas Shocks	HOLD008BKG
Performance w/ Foam Cell Shocks	HOLD008BKF
Constant Load w/ Gas Shocks	HOLD008CKG
Constant Load w/ Foam Cell Shocks	HOLD008CKF

SUSPENSION KIT CONTENTS

Shock Absorbers	Torsion Bars
Coil Springs	



Product	Part No.	Qty Req
---------	----------	---------

FRONT SUSPENSION

SHOCK ABSORBER

Nitro Gas	12667GR	2
Foam Cell	24667FE	2

TORSION BAR

Uprated Torsion Bars	HOLD009	1
----------------------	----------------	---

• Minimum 60mm downward suspension travel required

REAR SUSPENSION

SHOCK ABSORBER

Nitro Gas	12644GR	2
Foam Cell	24644FE	2

COIL SPRINGS

Estimated Lift

Additional Load

Performance	45mm	0 - 300kg	HOLD008B	1
Constant Load	45mm	300kg - GVM	HOLD008C	1

SUSPENSION KIT

Performance w/ Gas Shocks	HOLD008BKG1
Performance w/ Foam Cell Shocks	HOLD008BKF1
Constant Load w/ Gas Shocks	HOLD008CKG1
Constant Load w/ Foam Cell Shocks	HOLD008CKF1

SUSPENSION KIT CONTENTS

Shock Absorbers	Torsion Bars
Coil Springs	

RODEO

KB - TF
1991 - 1998



Product	Part No.	Qty Req
---------	----------	---------

FRONT SUSPENSION

SHOCK ABSORBER

Nitro Gas	12087GR	2
Foam Cell	24087FE	2

TORSION BAR

Uprated Torsion Bars	Suits 1981 - 1983	MAZDA003A	1
Uprated Torsion Bars	Suits 1983 - 1988	MAZDA005	1

• Minimum 60mm downward suspension travel required

REAR SUSPENSION

SHOCK ABSORBER

Nitro Gas Comfort	12636GRC	2
Nitro Gas	12636GR	2
Foam Cell Comfort	24636FEC	2
Foam Cell	24636FE	2

LEAF SPRING	Estimated Lift	Additional Load		
Constant Load Drivers Side	40mm	300kg - GVM	HOLD004CD/S	1
Constant Load Near Side	40mm	300kg - GVM	HOLD004CN/S	1

U-BOLTS

U-Bolt Kit	451UBK	2
------------	---------------	---

POLYURETHANE SPRING BUSHES

Bush Kit	728UK	1
----------	--------------	---

GREASABLE SHACKLES AND PINS

Greasable Shackle	791	2
Greasable Pin	792	2

LOAD PLUS

Load Plus Helper Springs	LP3	1
--------------------------	------------	---

SUSPENSION KIT

Performance w/ Gas Shocks	HOLD004BKG1
Performance w/ Foam Cell Shocks	HOLD004BKF1
Constant Load w/ Gas Shocks	HOLD004CKG1
Constant Load w/ Foam Cell Shocks	HOLD004CKF1

SUSPENSION KIT CONTENTS

Shock Absorbers	U-Bolts
Leaf Springs	Polyurethane Spring Bushes
Torsion Bars	



RODEO

KB - TFS
1988 - 3/2003

HOLDEN

Product **Part No.** **Qty Req**

FRONT SUSPENSION

SHOCK ABSORBER

Nitro Gas **12643GR** 2

TORSION BAR

Upated Torsion Bars **HOLD005A** 1

• Minimum 60mm downward suspension travel required

REAR SUSPENSION

SHOCK ABSORBER

Nitro Gas Comfort **12636GRC** 2

Nitro Gas **12636GR** 2

Foam Cell Comfort **24636FEC** 2

Foam Cell **24636FE** 2

LEAF SPRING

Estimated Lift

Additional Load

Performance Drivers Side 40mm 0 - 300kg **HOLD004BD/S** 1

Performance Near Side 40mm 0 - 300kg **HOLD004BN/S** 1

Constant Load Drivers Side 40mm 300kg - GVM **HOLD004CD/S** 1

Constant Load Near Side 40mm 300kg - GVM **HOLD004CN/S** 1

U-BOLTS

U-Bolt Kit **415UBK** 2

POLYURETHANE SPRING BUSHES

Bush Kit **728UK** 1

GREASABLE SHACKLES AND PINS

Greasable Shackle **386-2** 2

Non-Greasable Pin **387-1** 2

LOAD PLUS

Load Plus Helper Springs **LP3** 1

SUSPENSION KIT

Performance w/ Gas Shocks **HOLD004BKG2**

Constant Load w/ Gas Shocks **HOLD004CKG2**

SUSPENSION KIT CONTENTS

Shock Absorbers	U-Bolts
Leaf Springs	Polyurethane Spring Bushes
Torsion Bars	

RODEO / COLORADO / D-MAX

RA / RA7 / RC
2003 - 2012



Product **Part No.** **Qty Req**

FRONT SUSPENSION

SHOCK ABSORBER

Nitro Gas	12667GR	2
Foam Cell	24667FE	2

TORSION BAR

Up-rated Torsion Bars	HOLD010	1
-----------------------	----------------	---

• Minimum 60mm downward suspension travel required

REAR SUSPENSION

SHOCK ABSORBER

Nitro Gas Comfort	12636GRC	2
Nitro Gas	12636GR	2
Foam Cell Comfort	24636FEC	2
Foam Cell	24636FE	2

LEAF SPRING

	Estimated Lift	Additional Load		
Performance	40mm	0 - 300kg	HOLD006B	2
Constant Load	40mm	300kg - GVM	HOLD006C	2

U-BOLTS

U-Bolt Kit	417UBK	2
------------	---------------	---

POLYURETHANE SPRING BUSHES

Bush Kit	728TUK	1
----------	---------------	---

GREASABLE SHACKLES AND PINS

Greasable Shackle	386-2	2
Non-Greasable Pin	387-1	2

LOAD PLUS

• Not suitable for Rodeo / Colorado / D-Max with OEM springs due to interleaf liners

SUSPENSION KIT

Performance w/ Gas Shocks	HOLD006BKG
Performance w/ Foam Cell Shocks	HOLD006BKF
Constant Load w/ Gas Shocks	HOLD006CKG
Constant Load w/ Foam Cell Shocks	HOLD006CKF

SUSPENSION KIT CONTENTS

Shock Absorbers	U-Bolts
Leaf Springs	Polyurethane Spring Bushes
Torsion Bars	



Product	Part No.	Qty Req
---------	----------	---------

FRONT SUSPENSION

SHOCK ABSORBER

Nitro Gas Strut	12745GR	2
Foam Cell Strut	24745FE	2
Foam Cell Pro Strut	45745FE	2

• Height adjustable with Ironman 4x4 Strut Trim Packers

COIL SPRINGS

	Estimated Lift	Additional Load		
Standard	0mm	0 - 50kg	HOLD020S	1
Comfort	30mm	0 - 50kg	HOLD020A	1
Performance	40mm	0 - 50kg	HOLD020B	1
Constant Load	40mm	50 - 110kg	HOLD020C	1

TRIM PACKERS

5mm Strut Trim Packer	(Nitro Gas / Foam Cell)	HILFR05 / HILFR05F	2
10mm Strut Trim Packer	(Nitro Gas / Foam Cell)	HILFR10 / HILFR10F	2
15mm Strut Trim Packer	(Nitro Gas / Foam Cell)	HILFR15 / HILFR15F	2

• ONLY Compatible with Ironman 4x4 Struts (except Pro), lift height subject to 1:2 motion ratio. Unnecessary fitment may lift vehicle too high

REAR SUSPENSION

SHOCK ABSORBER

Nitro Gas Comfort	12636GRC	2
Nitro Gas	12636GR	2
Foam Cell Comfort	24636FEC	2
Foam Cell	24636FE	2
Foam Cell Pro Comfort	45636FEC	2
Foam Cell Pro	45636FE	2

LEAF SPRING

	Estimated Lift	Additional Load		
Comfort	30mm	0 - 200kg	HOLD021A	2
Performance	45mm	0 - 300kg	HOLD021B	2
Constant Load	45mm	300kg - GVM	HOLD021C	2

U-BOLTS

U-Bolt Kit	678UBK	2
------------	--------	---

POLYURETHANE SPRING BUSHES

Bush Kit	770UK	1
----------	-------	---

GREASABLE SHACKLES AND PINS

Greasable Shackle	1148	2
Non-Greasable Pin	387-1	2

LOAD PLUS

• Not suitable for Colorado with OEM springs due to interleaf liners

SUSPENSION KIT

Comfort w/ Gas Shocks	HOLD021AKG
Comfort w/ Foam Cell Shocks	HOLD021AKF
Comfort w/ Foam Cell Pro Shocks	HOLD021AKP
Performance w/ Gas Shocks	HOLD021BKG
Performance w/ Foam Cell Shocks	HOLD021BKF
Performance w/ Foam Cell Pro Shocks	HOLD021BKP
Constant Load w/ Gas Shocks	HOLD021CKG
Constant Load w/ Foam Cell Shocks	HOLD021CKF
Constant Load w/ Foam Cell Pro Shocks	HOLD021CKP

• Specify front coil springs when ordering

SUSPENSION KIT CONTENTS

Shock Absorbers	Leaf Springs
Strut Shock Absorbers	U-Bolts
Coil Springs	Polyurethane Spring Bushes

COLORADO 7

Trailblazer
2012+



Product

Part No.

Qty Req

FRONT SUSPENSION

SHOCK ABSORBER

Nitro Gas Strut			12745GR	2
Foam Cell Strut			24745FE	2
Foam Cell Pro Strut			45745FE	2

• Height adjustable with Ironman 4x4 Strut Trim Packers

COIL SPRINGS

Estimated Lift

Additional Load

	Estimated Lift	Additional Load		
Standard	0mm	0 - 50kg	HOLD020S	1
Comfort	30mm	0 - 50kg	HOLD020A	1
Performance	40mm	0 - 50kg	HOLD020B	1
Constant Load	40mm	50 - 110kg	HOLD020C	1

TRIM PACKERS

5mm Strut Trim Packer	(Nitro Gas / Foam Cell)	HILFR05 / HILFR05F	2
10mm Strut Trim Packer	(Nitro Gas / Foam Cell)	HILFR10 / HILFR10F	2
15mm Strut Trim Packer	(Nitro Gas / Foam Cell)	HILFR15 / HILFR15F	2

• ONLY Compatible with Ironman 4x4 Struts (except Pro), lift height subject to 1:2 motion ratio. Unnecessary fitment may lift vehicle too high

REAR SUSPENSION

SHOCK ABSORBER

Nitro Gas Comfort			12746GRC	2
Nitro Gas			12746GR	2
Foam Cell Comfort			24746FEC	2
Foam Cell			24746FE	2
Foam Cell Pro Comfort			45746FEC	2
Foam Cell Pro			45746FE	2

COIL SPRINGS

Estimated Lift

Additional Load

	Estimated Lift	Additional Load		
Standard	0mm	0 - 250kg	HOLD022S	1
Comfort	30mm	0 - 250kg	HOLD022A	1
Performance	40mm	0 - 250kg	HOLD022B	1
Constant Load	45mm	250kg - GVM	HOLD022C	1

SUSPENSION KIT

Standard w/ Gas Shocks	HOLD022SKG
Standard w/ Foam Cell Shocks	HOLD022SKF
Standard w/ Foam Cell Pro Shocks	HOLD022SKP
Comfort w/ Gas Shocks	HOLD022AKG
Comfort w/ Foam Cell Shocks	HOLD022AKF
Comfort w/ Foam Cell Pro Shocks	HOLD022AKP
Performance w/ Gas Shocks	HOLD022BKG
Performance w/ Foam Cell Shocks	HOLD022BKF
Performance w/ Foam Cell Pro Shocks	HOLD022BKP
Constant Load w/ Gas Shocks	HOLD022CKG
Constant Load w/ Foam Cell Shocks	HOLD022CKF
Constant Load w/ Foam Cell Pro Shocks	HOLD022CKP

• Specify front coil springs when ordering

SUSPENSION KIT CONTENTS

Shock Absorbers	Coil Springs
Strut Shock Absorbers	



Product

Part No.

Qty Req

FRONT SUSPENSION

SHOCK ABSORBER

Nitro Gas Strut			12745GR	2
Foam Cell Strut			24745FE	2
Foam Cell Pro Strut			45745FE	2

• Height adjustable with Ironman 4x4 Strut Trim Packers

COIL SPRINGS

	Estimated Lift	Additional Load		
Standard	0mm	0 - 50kg	HOLD020S	1
Comfort	30mm	0 - 50kg	HOLD020A	1
Performance	40mm	0 - 50kg	HOLD020B	1
Constant Load	40mm	50 - 110kg	HOLD020C	1

TRIM PACKERS

5mm Strut Trim Packer	(Nitro Gas / Foam Cell)	HILFR05 / HILFR05F	2
10mm Strut Trim Packer	(Nitro Gas / Foam Cell)	HILFR10 / HILFR10F	2
15mm Strut Trim Packer	(Nitro Gas / Foam Cell)	HILFR15 / HILFR15F	2

• ONLY Compatible with Ironman 4x4 Struts (except Pro), lift height subject to 1:2 motion ratio. Unnecessary fitment may lift vehicle too high

REAR SUSPENSION

SHOCK ABSORBER

Nitro Gas Comfort			12746GRC	2
Nitro Gas			12746GR	2
Foam Cell Comfort			24746FEC	2
Foam Cell			24746FE	2
Foam Cell Pro Comfort			45746FEC	2
Foam Cell Pro			45746FE	2

COIL SPRINGS

	Estimated Lift	Additional Load		
Performance	40mm	0 - 250kg	HOLD008B	1
Constant Load	40mm	250kg - GVM	HOLD008C	1

SUSPENSION KIT

Performance w/ Gas Shocks	HOLD020BKG
Performance w/ Foam Cell Shocks	HOLD020BKF
Performance w/ Foam Cell Pro Shocks	HOLD020BKP
Constant Load w/ Gas Shocks	HOLD020CKG
Constant Load w/ Foam Cell Shocks	HOLD020CKF
Constant Load w/ Foam Cell Pro Shocks	HOLD020CKP

• Specify front coil springs when ordering

SUSPENSION KIT CONTENTS

Shock Absorbers	Coil Springs
Strut Shock Absorbers	

TERRACAN

2001+



Product	Part No.	Qty Req
---------	----------	---------

FRONT SUSPENSION**SHOCK ABSORBER**

Nitro Gas	12087GR	2
Foam Cell	24087FE	2

TORSION BAR

Uprated Torsion Bars	HYUND004	1
----------------------	-----------------	---

- Minimum 60mm downward suspension travel required

REAR SUSPENSION**SHOCK ABSORBER**

Nitro Gas Comfort	12637GRC	2
Nitro Gas	12637GR	2

COIL SPRINGS**Estimated Lift****Additional Load**

	Estimated Lift	Additional Load		
Performance	40mm	0 - 300kg	HYUND003B	1

DIFF BREATHER EXTENDED

Breather Hose	DHOSE350	1
---------------	-----------------	---

SUSPENSION KIT

Performance w/ Gas Shocks	HYUND003BKG
---------------------------	--------------------

SUSPENSION KIT CONTENTS

Shock Absorbers	Torsion Bar
Coil Springs	Extended Breather Hose

**Product****Part No.****Qty Req****FRONT SUSPENSION****SHOCK ABSORBER**

Nitro Gas			12665GR	2
Foam Cell			24665FE	2

COIL SPRINGS**Estimated Lift****Additional Load**

Performance	45mm	0 - 100kg	JEEP016B	1
-------------	------	-----------	-----------------	---

STEERING DAMPER

Foam Cell			3540	1
-----------	--	--	-------------	---

REAR SUSPENSION**SHOCK ABSORBER**

Nitro Gas			12666GR	2
Foam Cell			24666FE	2

LEAF SPRING**Estimated Lift****Additional Load**

Performance Drivers Side	45mm	0 - 250kg	JEEP004BD/S	1
Performance Near Side	45mm	0 - 250kg	JEEP004BN/S	1

• In some cases a driveline vibration may occur after lift, a gearbox crossmember spacer may be required

U-BOLTS

U-Bolt Kit			512UBK	2
------------	--	--	---------------	---

POLYURETHANE SPRING BUSHES

Bush Kit			762UK	1
----------	--	--	--------------	---

SUSPENSION KIT

Performance w/ Gas Shocks	JEEP03BKG
Performance w/ Foam Cell Shocks	JEEP003BKF

• In some cases a driveline vibration may occur after lift, a gearbox crossmember spacer may be required

SUSPENSION KIT CONTENTS

Shock Absorbers	U-Bolts
Coil Springs	Polyurethane Spring Bushes
Leaf Springs	

WRANGLER

TJ
1996 - 2/2007



Product	Part No.	Qty Req
---------	----------	---------

FRONT SUSPENSION

SHOCK ABSORBER

Nitro Gas	12665GR	2
Foam Cell	24665FE	2

COIL SPRINGS

	Estimated Lift	Additional Load		
Performance	40mm	0 - 40kg	JEEP007B	1
Constant Load	40mm	40 - 80kg	JEEP003B	1

STEERING DAMPER

Foam Cell	3540	1
-----------	-------------	---

REAR SUSPENSION

SHOCK ABSORBER

Nitro Gas	12669GR	2
-----------	----------------	---

COIL SPRINGS

	Estimated Lift	Additional Load		
Performance	40mm	0 - 200kg	JEEP008B	1

- In some cases a driveline vibration may occur after lift, a gearbox crossmember spacer may be required

SUSPENSION KIT

Performance w/ Gas Shocks **JEEP007BKG**

- In some cases a driveline vibration may occur after lift, a gearbox crossmember spacer may be required
- Specify front coil springs when ordering

SUSPENSION KIT CONTENTS

Shock Absorbers
Coil Springs



Product	Part No.	Qty Req
---------	----------	---------

FRONT SUSPENSION

SHOCK ABSORBER

Nitro Gas		12751GR	2
Foam Cell Pro		45751FE	2
Nitro Gas	Suits 4" Lift	12751LGR	2

• 4" Lift components should only be used together with appropriate geometry correction components

COIL SPRINGS	Estimated Lift	Additional Load		
Performance	40mm	0 - 50kg	JEEP017B	1
Constant Load	40mm	50 - 110kg	JEEP017C	1
Performance 4" Lift	100mm	0 - 50kg	JEEP019B	1

• 4" Lift components should only be used together with appropriate geometry correction components

STEERING DAMPER

Foam Cell	Regular Fitment	3541	1
Foam Cell	Suits JKBKITL 4" Kit Only	3540	1

PANHARD ROD

Adjustable Panhard Rod	PANHARD010	1
------------------------	-------------------	---

REAR SUSPENSION

SHOCK ABSORBER

Nitro Gas		12752GR	2
Foam Cell Pro		45752FE	2
Nitro Gas	Suits 4" Lift	12752LGR	2

• 4" Lift components should only be used together with appropriate geometry correction components

COIL SPRINGS	Estimated Lift	Additional Load		
Performance 2 Door	40mm	0 - 250kg	JEEP018A	1
Performance 4 Door	40mm	0 - 250kg	JEEP018B	1
Performance 4" Lift	100mm	0 - 250kg	JEEP020B	1

• 4" Lift components should only be used together with appropriate geometry correction components

PANHARD ROD

Adjustable Panhard Rod	PANHARD011	1
------------------------	-------------------	---

SWAY BAR LINK

Extended Sway Bar Link	SBEXT008	2
------------------------	-----------------	---

• OEM Rear Links can be moved to the front of vehicle.

BRACKET KIT

4" Lift Bracket Set	Left Hand Drive Models ONLY	JKBKITL	1
---------------------	-----------------------------	----------------	---

• Bracket set is sold complete. Parts are not available individually

SUSPENSION KIT

2 Door Performance w/ Gas Shocks	JEEP017AKG
2 Door Performance w/ Foam Cell Pro Shocks	JEEP017AKP
4 Door Performance w/ Gas Shocks	JEEP017BKG
4 Door Performance w/ Foam Cell Pro Shocks	JEEP017BKP
4" Lift Performance w/ Gas Shocks	JEEP019BKGL

• 4" Lift may not be legal for road use in your area. Certification may be required for on-road use

• 4" Lift Kit suits left hand drive models ONLY

SUSPENSION KIT CONTENTS

Shock Absorbers
Coil Springs

4" SUSPENSION KIT CONTENTS

Shock Absorbers	Steering Damper
Coil Springs	4" Bracket Set

4" BRACKET SET CONTENTS

Steering Rod Flip Kit - JKBK01L	Rear Adjustable Panhard Rod - PANHARD012
Front Shock Absorber Relocation Kit - JKBK02	Rear Panhard Rod Relocation Kit - JKBK05L
Radius Arm Relocation Kit - JKBK03	Bump Stop Spacer Kit - JKBK06
Brake Hose Extension Kit - JKBK04	Adjustable Swaybar Extensions - SBEXT008
Front Adjustable Panhard Rod - PANHARD010	

GRAND CHEROKEE

ZJ/ZG
1993-1998



Product	Part No.	Qty Req
---------	----------	---------

FRONT SUSPENSION

SHOCK ABSORBER

Nitro Gas	12665GR	2
Foam Cell	24665FE	2

COIL SPRINGS

	Estimated Lift	Additional Load		
Performance	40mm	0 - 50kg	JEEP003B	1
Constant Load	40mm	50 - 100kg	JEEP016B	1

STEERING DAMPER

Foam Cell	3540	1
-----------	-------------	---

REAR SUSPENSION

SHOCK ABSORBER

Nitro Gas	12670GR	2
-----------	----------------	---

COIL SPRINGS

	Estimated Lift	Additional Load		
Performance	40mm	0 - 200kg	JEEP006B	1
Constant Load	40mm	200kg - GVM	JEEP003B	1

SUSPENSION KIT

Performance w/ Gas Shocks	JEEP006BKG
Constant Load w/ Gas Shocks	JEEP006CKG

• Vehicles with Monocoque body construction can be subject to increased NVH (Noise) with upgraded suspension installed

SUSPENSION KIT CONTENTS

- Shock Absorbers
- Coil Springs



Product

Part No.

Qty Req

FRONT SUSPENSION

SHOCK ABSORBER

Nitro Gas			12774GR	2
-----------	--	--	----------------	---

COIL SPRINGS

	Estimated Lift	Additional Load		
Performance	40mm	0 - 50kg	JEEP012B	1

REAR SUSPENSION

SHOCK ABSORBER

Nitro Gas			12775GR	2
-----------	--	--	----------------	---

COIL SPRINGS

	Estimated Lift	Additional Load		
Performance	40mm	0 - 200kg	JEEP013B	1

SUSPENSION KIT

Performance w/ Gas Shocks	JEEP012BKG
---------------------------	-------------------

- Vehicles with Monocoque body construction can be subject to increased NVH (Noise) with upgraded suspension installed

SUSPENSION KIT CONTENTS

Shock Absorbers
Coil Springs

CHEROKEE

Liberty KJ
2001-2006



Product

Part No.

Qty Req

FRONT SUSPENSION

SHOCK ABSORBER

Nitro Gas Strut		12711GR	2
-----------------	--	----------------	---

• Height adjustable with Ironman 4x4 Strut Trim Packers

COIL SPRINGS

Estimated Lift

Additional Load

	Estimated Lift	Additional Load	Part No.	Qty Req
Performance	40mm	0 - 50kg	JEEP014B	1
Constant Load or Diesel	40mm	50 - 100kg	JEEP014C	1

TRIM PACKERS

5mm Nitro Gas Strut Trim Packer		HILFR05	2
10mm Nitro Gas Strut Trim Packer		HILFR10	2
15mm Nitro Gas Strut Trim Packer		HILFR15	2

• ONLY Compatible with Ironman 4x4 Struts, lift height subject to 1:2 motion ratio. Unnecessary fitment may lift vehicle too high

REAR SUSPENSION

SHOCK ABSORBER

Nitro Gas		12712GR	2
-----------	--	----------------	---

COIL SPRINGS

Estimated Lift

Additional Load

Performance	40mm	0 - 200kg	JEEP015B	1
-------------	------	-----------	-----------------	---

SUSPENSION KIT

Performance w/ Gas Shocks	JEEP014BKG
Performance w/ Gas Shocks (Diesel)	JEEP014BKG1

• Vehicles with Monocoque body construction can be subject to increased NVH (Noise) with upgraded suspension installed

SUSPENSION KIT CONTENTS

Shock Absorbers
Coil Springs

**Product****Part No.****Qty Req****FRONT SUSPENSION****SHOCK ABSORBER**

Nitro Gas	12711GR	2
-----------	----------------	---

- Height adjustable with Ironman 4x4 Strut Trim Packers

TRIM PACKERS

5mm Nitro Gas Strut Trim Packer	HILFR05	2
---------------------------------	----------------	---

10mm Nitro Gas Strut Trim Packer	HILFR10	2
----------------------------------	----------------	---

15mm Nitro Gas Strut Trim Packer	HILFR15	2
----------------------------------	----------------	---

- ONLY Compatible with Ironman 4x4 Struts, lift height subject to 1:2 motion ratio. Unnecessary fitment may lift vehicle too high

REAR SUSPENSION**SHOCK ABSORBER**

Nitro Gas	12712GR	2
-----------	----------------	---

- Vehicles with Monocoque body construction can be subject to increased NVH (Noise) with upgraded suspension installed



Product	Part No.	Qty Req
---------	----------	---------

FRONT SUSPENSION

COIL SPRINGS	Estimated Lift	Additional Load	Part No.	Qty Req
Performance	35mm	0 - 50kg	KIA006B	1

REAR SUSPENSION

COIL SPRINGS	Estimated Lift	Additional Load	Part No.	Qty Req
Performance	35mm	0 - 200kg	KIA007B	1



Product

Part No.

Qty Req

FRONT SUSPENSION

COIL SPRINGS	Estimated Lift	Additional Load		
Performance	35mm	0 - 50kg	LADA001B	1

REAR SUSPENSION

COIL SPRINGS	Estimated Lift	Additional Load		
Performance	35mm	0 - 200kg	LADA002B	1

DEFENDER

90 Series



Product

Part No.

Qty Req

FRONT SUSPENSION

SHOCK ABSORBER

Nitro Gas			12080GR	2
Foam Cell			24080FE	2
Foam Cell Pro			45080FE	2

COIL SPRINGS

Estimated Lift

Additional Load

Performance	45mm	0 - 80kg	LAND009B	1
-------------	------	----------	-----------------	---

STEERING DAMPER

Foam Cell			3532	1
-----------	--	--	-------------	---

OFFSET CASTER BUSH KIT

Offset Bush Kit	Suits 1987+		1145SK	1
-----------------	-------------	--	---------------	---

• May cause driveline vibration on 1998+ models

REAR SUSPENSION

SHOCK ABSORBER

Nitro Gas			12640GR	2
Foam Cell			24640FE	2
Foam Cell Pro			45640FE	2

COIL SPRINGS

Estimated Lift

Additional Load

Performance	45mm	0 - 300kg	LAND011B	1
Constant Load	45mm	300kg - GVM	LAND011C	1

BUSH KIT

Suspension Arm Bush Kit	KA Chassis		821K	1
Suspension Arm Bush Kit	LA/YA Chassis		811K	1

SUSPENSION KIT

Performance w/ Gas Shocks	LAND009BKG
Performance w/ Foam Cell Shocks	LAND009BKF
Performance w/ Foam Cell Pro Shocks	LAND009BKP
Constant Load w/ Gas Shocks	LAND009CKG
Constant Load w/ Foam Cell Shocks	LAND009CKF
Constant Load w/ Foam Cell Pro Shocks	LAND009CKP

SUSPENSION KIT CONTENTS

- Shock Absorbers
- Coil Springs



Product	Part No.	Qty Req
---------	----------	---------

FRONT SUSPENSION

SHOCK ABSORBER

Nitro Gas	12080GR	2
Foam Cell	24080FE	2
Foam Cell Pro	45080FE	2

COIL SPRINGS **Estimated Lift** **Additional Load**

Performance	45mm	0 - 80kg	LAND007B	1
-------------	------	----------	-----------------	---

STEERING DAMPER

Foam Cell	3532	1
-----------	-------------	---

OFFSET CASTER BUSH KIT

Offset Bush Kit	Suits 1987+	1145SK	1
-----------------	-------------	---------------	---

• May cause driveline vibration on 1998+ models

REAR SUSPENSION

SHOCK ABSORBER

Nitro Gas	12640GR	2
Foam Cell	24640FE	2
Foam Cell Pro	45640FE	2

COIL SPRINGS **Estimated Lift** **Additional Load**

Performance	45mm	0 - 300kg	LAND006B	1
Constant Load	45mm	300kg - GVM	LAND006C	1

BUSH KIT

Suspension Arm Bush Kit	KA Chassis	821K	1
Suspension Arm Bush Kit	LA/YA Chassis	811K	1

SUSPENSION KIT

Performance w/ Gas Shocks	LAND007BKG
Performance w/ Foam Cell Shocks	LAND007BKF
Performance w/ Foam Cell Pro Shocks	LAND007BKP
Constant Load w/ Gas Shocks	LAND007CKG
Constant Load w/ Foam Cell Shocks	LAND007CKF
Constant Load w/ Foam Cell Pro Shocks	LAND007CKP

SUSPENSION KIT CONTENTS

- Shock Absorbers
- Coil Springs

DEFENDER

110, 130 Series County / Dual Cab



Product

Part No.

Qty Req

FRONT SUSPENSION

SHOCK ABSORBER

Nitro Gas			12080GR	2
Foam Cell			24080FE	2
Foam Cell Pro			45080FE	2

COIL SPRINGS

Estimated Lift

Additional Load

Performance	45mm	0 - 80kg	LAND005B	1
-------------	------	----------	-----------------	---

STEERING DAMPER

Foam Cell			3532	1
-----------	--	--	-------------	---

OFFSET CASTER BUSH KIT

Offset Bush Kit	Suits 1987+		1145SK	1
-----------------	-------------	--	---------------	---

• May cause driveline vibration on 1998+ models

REAR SUSPENSION

SHOCK ABSORBER

Nitro Gas			12640GR	2
Foam Cell			24640FE	2
Foam Cell Pro			45640FE	2

COIL SPRINGS

Estimated Lift

Additional Load

Performance (Self Leveling)	45mm	0 - 300kg	LAND008B	1
Performance	45mm	0 - 300kg	LAND006B	1
Constant Load	45mm	300kg - GVM	LAND006C	1

• Re-Fit inner spring if equipped

BUSH KIT

Suspension Arm Bush Kit	KA Chassis		821K	1
Suspension Arm Bush Kit	LA/YA Chassis		811K	1

SUSPENSION KIT

Performance w/ Gas Shocks w/ Self Leveling	LAND005BKG
Performance w/ Foam Cell Shocks w/ Self Leveling	LAND005BKF
Performance w/ Foam Cell Pro Shocks w/ Self Leveling	LAND005BKP
Performance w/ Gas Shocks	LAND006BKG
Performance w/ Foam Cell Shocks	LAND006BKF
Performance w/ Foam Cell Pro Shocks	LAND006BKP
Constant Load w/ Gas Shocks	LAND006CKG
Constant Load w/ Foam Cell Shocks	LAND006CKF
Constant Load w/ Foam Cell Pro Shocks	LAND006CKP

SUSPENSION KIT CONTENTS

- Shock Absorbers
- Coil Springs



Product

Part No.

Qty Req

FRONT SUSPENSION

SHOCK ABSORBER

Nitro Gas			12080GR	2
Foam Cell			24080FE	2
Foam Cell Pro			45080FE	2

COIL SPRINGS

Estimated Lift

Additional Load

Performance	40mm	0 - 50kg	LAND009B	1
Constant Load	40mm	50 - 110kg	LAND007B	1

STEERING DAMPER

Foam Cell			3511	1
-----------	--	--	-------------	---

OFFSET CASTER BUSH KIT

Offset Bush Kit	Suits 1986+		1145SK	1
-----------------	-------------	--	---------------	---

• May cause driveline vibration in automatic transmission models

REAR SUSPENSION

SHOCK ABSORBER

Nitro Gas			12640GR	2
Foam Cell			24640FE	2
Foam Cell Pro			45640FE	2

COIL SPRINGS

Estimated Lift

Additional Load

Performance	40mm	0 - 300kg	LAND011B	1
Constant Load	40mm	300kg - GVM	LAND011C	1

BUSH KIT

Suspension Arm Bush Kit	Suits pre 1986		801K	1
Suspension Arm Bush Kit	Suits 1986+		811K	1

SUSPENSION KIT

Performance w/ Gas Shocks	LAND009BKG
Performance w/ Foam Cell Shocks	LAND009BKF
Performance w/ Foam Cell Pro Shocks	LAND009BKP
Constant Load w/ Gas Shocks	LAND009CKG
Constant Load w/ Foam Cell Shocks	LAND009CKF
Constant Load w/ Foam Cell Pro Shocks	LAND009CKP

SUSPENSION KIT CONTENTS

Shock Absorbers
Coil Springs

DISCOVERY

Series 1
1989-1998



Product	Part No.	Qty Req
---------	----------	---------

FRONT SUSPENSION

SHOCK ABSORBER

Nitro Gas		12080GR	2
Foam Cell		24080FE	2
Foam Cell Pro		45080FE	2

COIL SPRINGS

	Estimated Lift	Additional Load		
--	----------------	-----------------	--	--

Performance	40mm	0 - 50kg	LAND009B	1
Constant Load	40mm	50 - 110kg	LAND007B	1

STEERING DAMPER

Foam Cell		3511	1
-----------	--	-------------	---

OFFSET CASTER BUSH KIT

Offset Bush Kit		1145SK	1
-----------------	--	---------------	---

• May cause driveline vibration in automatic transmission models

REAR SUSPENSION

SHOCK ABSORBER

Nitro Gas		12640GR	2
Foam Cell		24640FE	2
Foam Cell Pro		45640FE	2

COIL SPRINGS

	Estimated Lift	Additional Load		
--	----------------	-----------------	--	--

Performance	40mm	0 - 300kg	LAND011B	1
Constant Load	40mm	300kg - GVM	LAND011C	1

BUSH KIT

Suspension Arm Bush Kit		811K	1
-------------------------	--	-------------	---

SUSPENSION KIT

Performance w/ Gas Shocks	LAND009BKG
Performance w/ Foam Cell Shocks	LAND009BKF
Performance w/ Foam Cell Pro Shocks	LAND009BKP
Constant Load w/ Gas Shocks	LAND009CKG
Constant Load w/ Foam Cell Shocks	LAND009CKF
Constant Load w/ Foam Cell Pro Shocks	LAND009CKP

SUSPENSION KIT CONTENTS

Shock Absorbers
Coil Springs

**Product****Part No.****Qty Req****FRONT SUSPENSION****SHOCK ABSORBER**

Nitro Gas			12776GR	2
Foam Cell			24776FE	2

COIL SPRINGS**Estimated Lift****Additional Load**

	Estimated Lift	Additional Load		
Performance	40mm	0 - 50kg	LAND014B	1
Constant Load	40mm	50 - 110kg	LAND009B	1

STEERING DAMPER

Foam Cell			3502	1
-----------	--	--	-------------	---

REAR SUSPENSION**SHOCK ABSORBER**

Nitro Gas			12777GR	2
Foam Cell			24777FE	2

COIL SPRINGS**Estimated Lift****Additional Load**

	Estimated Lift	Additional Load		
Performance	40mm	0 - 300kg	LAND011B	1
Constant Load	40mm	300kg - GVM	LAND011C	1

SUSPENSION KIT

Performance w/ Gas Shocks	LAND014BKG
Performance w/ Foam Cell Shocks	LAND014BKF
Constant Load w/ Gas Shocks	LAND014CKG
Constant Load w/ Foam Cell Shocks	LAND014CKF

SUSPENSION KIT CONTENTS

Shock Absorbers
Coil Springs

DISCOVERY

Series 3 LR3 (Coil Spring)
2004-2009



Product **Part No.** **Qty Req**

FRONT SUSPENSION

COIL SPRINGS	Estimated Lift	Additional Load		
Performance	45mm	0 - 50kg	LAND019B	1
Constant Load	45mm	50 - 100kg	LAND019C	1

REAR SUSPENSION

COIL SPRINGS	Estimated Lift	Additional Load		
Performance	45mm	0 - 200kg	LAND020B	1
Constant Load	45mm	200kg - GVM	LAND020C	1



Product	Part No.	Qty Req
FRONT SUSPENSION		
SHOCK ABSORBER		
Nitro Gas	12087GR	2
TORSION BAR		
Upated Torsion Bars	MAH001	1
• Minimum 60mm downward suspension travel required		
REAR SUSPENSION		
SHOCK ABSORBER		
Nitro Gas	12749GR	2
• Check shock absorber specifications, some models can vary		
LEAF SPRING	Estimated Lift	Additional Load
Performance	40mm	0 - 200kg
		MAH002B
		2
U-BOLTS		
U-Bolt Kit	1103UBK	2
POLYURETHANE SPRING BUSHES		
Bush Kit	719UK	1
GREASABLE SHACKLES AND PINS		
Greasable Shackle	Left side	353LH
Greasable Shackle	Right side	353RH
Greasable Pin		1149
		2
LOAD PLUS		
Load Plus Helper Springs	LP4	1
SUSPENSION KIT		
Performance w/ Gas Shocks	MAH002BKG	

SUSPENSION KIT CONTENTS

Shock Absorbers	U-Bolts
Leaf Springs	Polyurethane Spring Bushes
Torsion Bars	

SCORPIO WAGON

2002+



Product	Part No.	Qty Req
---------	----------	---------

FRONT SUSPENSION

SHOCK ABSORBER

Nitro Gas	12087GR	2
-----------	---------	---

TORSION BAR

Upated Torsion Bars	MAH001	1
---------------------	--------	---

• Minimum 60mm downward suspension travel required

REAR SUSPENSION

SHOCK ABSORBER

Nitro Gas	12749GR	2
-----------	---------	---

• Check shock absorber specifications, some models can vary

COIL SPRINGS

Estimated Lift

Additional Load

Performance	40mm	0 - 200kg	MAH003B	1
-------------	------	-----------	---------	---

SUSPENSION KIT

Performance w/ Gas Shocks	MAH003BKG
---------------------------	-----------

SUSPENSION KIT CONTENTS

Shock Absorbers

Coil Springs



Product

Part No.

Qty Req

FRONT SUSPENSION

SHOCK ABSORBER

Nitro Gas	12667GR	2
Foam Cell	24667FE	2
Foam Cell Pro	45667FE	2

TORSION BAR

Up-rated Torsion Bars	MAZDA005	1
-----------------------	-----------------	---

• Minimum 60mm downward suspension travel required

REAR SUSPENSION

SHOCK ABSORBER

Nitro Gas Comfort	12095GRC	2
Nitro Gas	12095GR	2
Foam Cell Comfort	24095FEC	2
Foam Cell	24095FE	2
Foam Cell Pro Comfort	45095FEC	2
Foam Cell Pro	45095FE	2

LEAF SPRING

Estimated Lift

Additional Load

	Estimated Lift	Additional Load		
Comfort	40mm	0 - 100kg	MAZDA006A	2
Performance	40mm	0 - 200kg	MAZDA006B	2
Constant Load	40mm	200 - 400kg	MAZDA006C	2
Extra Constant Load	40mm	400kg - GVM	MAZDA006D	2

U-BOLTS

U-Bolt Kit	415UBK	2
------------	---------------	---

POLYURETHANE SPRING BUSHES

Bush Kit	756UK	1
----------	--------------	---

GREASABLE SHACKLES AND PINS

Greasable Shackle	386-1	2
Greasable Pin	794	2

LOAD PLUS

Load Plus Helper Springs	LP3	1
--------------------------	------------	---

SUSPENSION KIT

Comfort w/ Gas Shocks	MAZDA006AKG
Comfort w/ Foam Cell Shocks	MAZDA006AKF
Comfort w/ Foam Cell Pro Shocks	MAZDA006AKP
Performance w/ Gas Shocks	MAZDA006BKG
Performance w/ Foam Cell Shocks	MAZDA006BKF
Performance w/ Foam Cell Pro Shocks	MAZDA006BKP
Constant Load w/ Gas Shocks	MAZDA006CKG
Constant Load w/ Foam Cell Shocks	MAZDA006CKF
Constant Load w/ Foam Cell Pro Shocks	MAZDA006CKP
Extra Constant Load w/ Gas Shocks	MAZDA006DKG
Extra Constant Load w/ Foam Cell Shocks	MAZDA006DKF
Extra Constant Load w/ Foam Cell Pro Shocks	MAZDA006DKP

SUSPENSION KIT CONTENTS

Shock Absorbers	U-Bolts
Leaf Springs	Polyurethane Spring Bushes
Torsion Bars	



Product

Part No.

Qty Req

FRONT SUSPENSION

SHOCK ABSORBER

Nitro Gas		12667GR	2
Foam Cell		24667FE	2
Foam Cell Pro		45667FE	2

TORSION BAR

Uprated Torsion Bars	Duratorq Engine	MAZDA014	1
Uprated Torsion Bars	2.5L WLT Engine	MAZDA005	1

- MAZDA014 is 1024mm in length, used on most vehicles. Vehicles with 2.5L WLT Engine use MAZDA005 (924mm) Torsion Bar
- Minimum 60mm downward suspension travel required

REAR SUSPENSION

SHOCK ABSORBER

Nitro Gas Comfort		12095GRC	2
Nitro Gas		12095GR	2
Foam Cell Comfort		24095FEC	2
Foam Cell		24095FE	2
Foam Cell Pro Comfort		45095FEC	2
Foam Cell Pro		45095FE	2

LEAF SPRING

Estimated Lift

Additional Load

Comfort	40mm	0 - 100kg	MAZDA041A	2
Performance	40mm	0 - 200kg	MAZDA041B	2
Constant Load	40mm	200 - 400kg	MAZDA041C	2
Extra Constant Load	40mm	400kg - GVM	MAZDA041D	2

U-BOLTS

U-Bolt Kit		417UBK	2
------------	--	---------------	---

POLYURETHANE SPRING BUSHES

Bush Kit		759UK	1
----------	--	--------------	---

GREASABLE SHACKLES AND PINS

Greasable Shackle		386-1	2
-------------------	--	--------------	---

LOAD PLUS

Load Plus Helper Springs		LP3	1
--------------------------	--	------------	---

SUSPENSION KIT

Comfort w/ Gas Shocks	MAZDA041AKG
Comfort w/ Foam Cell Shocks	MAZDA041AKF
Comfort w/ Foam Cell Pro Shocks	MAZDA041AKP
Performance w/ Gas Shocks	MAZDA041BKG
Performance w/ Foam Cell Shocks	MAZDA041BKF
Performance w/ Foam Cell Pro Shocks	MAZDA041BKP
Constant Load w/ Gas Shocks	MAZDA041CKG
Constant Load w/ Foam Cell Shocks	MAZDA041CKF
Constant Load w/ Foam Cell Pro Shocks	MAZDA041CKP
Extra Constant Load w/ Gas Shocks	MAZDA041DKG
Extra Constant Load w/ Foam Cell Shocks	MAZDA041DKF
Extra Constant Load w/ Foam Cell Pro Shocks	MAZDA041DKP

- Check Torsion Bar length before ordering

SUSPENSION KIT CONTENTS

Shock Absorbers	U-Bolts
Leaf Springs	Polyurethane Spring Bushes
Torsion Bars	



Product

Part No.

Qty Req

FRONT SUSPENSION

SHOCK ABSORBER

Nitro Gas Strut	12727GR	2
Foam Cell Strut	24727FE	2
Foam Cell Pro Strut	45727FE	2

• Height adjustable with Ironman 4x4 Strut Trim Packers

COIL SPRINGS

	Estimated Lift	Additional Load		
Standard	0mm	0 - 50kg	FOR001S	1
Comfort	35mm	0 - 50kg	FOR001A	1
Performance	40mm	0 - 50kg	FOR001B	1
Constant Load	40mm	50 - 110kg	FOR001C	1

TRIM PACKERS

5mm Strut Trim Packer	(Nitro Gas / Foam Cell)	HILFR05 / HILFR05F	2
10mm Strut Trim Packer	(Nitro Gas / Foam Cell)	HILFR10 / HILFR10F	2
15mm Strut Trim Packer	(Nitro Gas / Foam Cell)	HILFR15 / HILFR15F	2

• ONLY Compatible with Ironman 4x4 Struts (except Pro), lift height subject to 1:2 motion ratio. Unnecessary fitment may lift vehicle too high

REAR SUSPENSION

SHOCK ABSORBER

Nitro Gas Comfort	12095GRC	2
Nitro Gas	12095GR	2
Foam Cell Comfort	24095FEC	2
Foam Cell	24095FE	2
Foam Cell Pro Comfort	45095FEC	2
Foam Cell Pro	45095FE	2

LEAF SPRING

	Estimated Lift	Additional Load		
Comfort	40mm	0 - 200kg	FOR002A	2
Performance	45mm	0 - 300kg	FOR002B	2
Constant Load	45mm	300kg - GVM	FOR002C	2

U-BOLTS

U-Bolt Kit	417UBK	2
------------	---------------	---

POLYURETHANE SPRING BUSHES

Bush Kit	1193UK	1
----------	---------------	---

DRIVELINE SPACERS

Centre Bearing Spacer Kit	1194K	1
---------------------------	--------------	---

GREASABLE SHACKLES AND PINS

Greasable Shackle	1147	2
Non-Greasable Pin	387-1	2

LOAD PLUS

Load Plus Helper Springs	LP3	1
--------------------------	------------	---

SUSPENSION KIT

Comfort w/ Gas Shocks	FOR001AKG
Comfort w/ Foam Cell Shocks	FOR001AKF
Comfort w/ Foam Cell Pro Shocks	FOR001AKP
Performance w/ Gas Shocks	FOR001BKG
Performance w/ Foam Cell Shocks	FOR001BKF
Performance w/ Foam Cell Pro Shocks	FOR001BKP
Constant Load w/ Gas Shocks	FOR001CKG
Constant Load w/ Foam Cell Shocks	FOR001CKF
Constant Load w/ Foam Cell Pro Shocks	FOR001CKP

• Specify front coil springs when ordering

SUSPENSION KIT CONTENTS

Shock Absorbers	Leaf Springs	Centre Bearing Spacer Kit
Strut Shock Absorbers	U-Bolts	
Coil Springs	Polyurethane Spring Bushes	

G-WAGEN

G55 AMG



Product

Part No.

Qty Req

FRONT SUSPENSION

SHOCK ABSORBER

Foam Cell

24788FE

2

COIL SPRINGS

Estimated Lift

Additional Load

Performance

45mm

0 - 50kg

MERC015B

1

REAR SUSPENSION

SHOCK ABSORBER

Foam Cell

24789FE

2

COIL SPRING

Estimated Lift

Additional Load

Performance

45mm

0 - 300kg

MERC016B

1

SUSPENSION KIT

Performance w/ Foam Cell Shocks

MERC015BKF

SUSPENSION KIT CONTENTS

Shock Absorbers

Coil Springs



TRITON

L200
Pre 1993

MITSUBISHI

Product **Part No.** **Qty Req**

FRONT SUSPENSION

SHOCK ABSORBER

Nitro Gas	12082GR	2
Foam Cell	24082FE	2

TORSION BAR

Up-rated Torsion Bars	MITS013	1
-----------------------	----------------	---

• Minimum 60mm downward suspension travel required

STEERING DAMPER

Foam Cell	Suits vehicles w/o power steering	3517	1
-----------	-----------------------------------	-------------	---

REAR SUSPENSION

SHOCK ABSORBER

Nitro Gas Comfort	12636GRC	2
Nitro Gas	12636GR	2
Foam Cell Comfort	24636FEC	2
Foam Cell	24636FE	2

LEAF SPRING

Estimated Lift

Additional Load

Performance	45mm	0 - 300kg	MITS018B	2
Constant Load	45mm	300kg - GVM	MITS018C	2

• Must use Ironman 4x4 bushes

U-BOLTS

U-Bolt Kit	451UBK	2
------------	---------------	---

POLYURETHANE SPRING BUSHES

Bush Kit	715UK	1
----------	--------------	---

GREASABLE SHACKLES AND PINS

Greasable Shackle	795	2
Greasable Pin	796	2

LOAD PLUS

Load Plus Helper Springs	LP4	1
--------------------------	------------	---

SUSPENSION KIT

Performance w/ Gas Shocks	MITS018BKG1
Performance w/ Foam Cell Shocks	MITS018BKF1
Constant Load w/ Gas Shocks	MITS018CKG1
Constant Load w/ Foam Cell Shocks	MITS018CKF1

SUSPENSION KIT CONTENTS

Shock Absorbers	U-Bolts
Leaf Springs	Polyurethane Spring Bushes
Torsion Bars	



Product	Part No.	Qty Req
---------	----------	---------

FRONT SUSPENSION

SHOCK ABSORBER

Nitro Gas	12082GR	2
Foam Cell	24082FE	2

TORSION BAR

Uprated Torsion Bars	MITSO15C	1
----------------------	-----------------	---

• Minimum 60mm downward suspension travel required

STEERING DAMPER

Foam Cell	Suits vehicles w/o power steering	3517	1
-----------	-----------------------------------	-------------	---

REAR SUSPENSION

SHOCK ABSORBER

Nitro Gas Comfort	12636GRC	2
Nitro Gas	12636GR	2
Foam Cell Comfort	24636FEC	2
Foam Cell	24636FE	2

LEAF SPRING

Estimated Lift

Additional Load

Performance	40mm	0 - 300kg	MITSO18B	2
Constant Load	40mm	300kg - GVM	MITSO18C	2

• Must use Ironman 4x4 bushes

U-BOLTS

U-Bolt Kit	451UBK	2
------------	---------------	---

POLYURETHANE SPRING BUSHES

Bush Kit	715TUK	1
----------	---------------	---

GREASABLE SHACKLES AND PINS

Greasable Shackle	795	2
Non-Greasable Pin	387-1	2

LOAD PLUS

Load Plus Helper Springs	LP4	1
--------------------------	------------	---

SUSPENSION KIT

Performance w/ Gas Shocks	MITSO15BKG
Performance w/ Foam Cell Shocks	MITSO15BKF
Constant Load w/ Gas Shocks	MITSO15CKG
Constant Load w/ Foam Cell Shocks	MITSO15CKF

SUSPENSION KIT CONTENTS

Shock Absorbers	U-Bolts
Leaf Springs	Polyurethane Spring Bushes
Torsion Bars	



TRITON

MK

1996-2006

MITSUBISHI

Product	Part No.	Qty Req
---------	----------	---------

FRONT SUSPENSION

SHOCK ABSORBER

Nitro Gas	12087GR	2
Foam Cell	24087FE	2

TORSION BAR

Up-rated Torsion Bars	MITS015C	1
-----------------------	-----------------	---

• Minimum 60mm downward suspension travel required

STEERING DAMPER

Foam Cell	Suits vehicles w/o power steering	3517	1
-----------	-----------------------------------	-------------	---

REAR SUSPENSION

SHOCK ABSORBER

Nitro Gas Comfort	12698GRC	2
Nitro Gas	12698GR	2
Foam Cell Comfort	24698FEC	2
Foam Cell	24698FE	2

LEAF SPRING

Estimated Lift

Additional Load

Performance	40mm	0 - 300kg	MITS018B	2
Constant Load	40mm	300kg - GVM	MITS018C	2

• Must use Ironman 4x4 bushes

U-BOLTS

U-Bolt Kit	451UBK	2
------------	---------------	---

POLYURETHANE SPRING BUSHES

Bush Kit	715TUK	1
----------	---------------	---

GREASABLE SHACKLES AND PINS

Greasable Shackle	795	2
Non-Greasable Pin	387-1	2

LOAD PLUS

Load Plus Helper Springs	LP4	1
--------------------------	------------	---

SUSPENSION KIT

Performance w/ Gas Shocks	MITS015BKG1
Performance w/ Foam Cell Shocks	MITS015BKF1
Constant Load w/ Gas Shocks	MITS015CKG1
Constant Load w/ Foam Cell Shocks	MITS015CKF1

SUSPENSION KIT CONTENTS

Shock Absorbers	U-Bolts
Leaf Springs	Polyurethane Spring Bushes
Torsion Bars	



Product	Part No.	Qty Req
---------	----------	---------

FRONT SUSPENSION

SHOCK ABSORBER

Nitro Gas Strut	12715GR	2
Foam Cell Strut	24715FE	2

• Height adjustable with Ironman 4x4 Strut Trim Packers

COIL SPRINGS	Estimated Lift	Additional Load		
Standard	0mm	0 - 50kg	MITSO40S	1
Comfort	35mm	0 - 50kg	MITSO40A	1
Performance	40mm	0 - 80kg	MITSO40B	1
Constant Load	40mm	80 - 110kg	MITSO40C	1

TRIM PACKERS

5mm Strut Trim Packer	(Nitro Gas / Foam Cell)	HILFR05 / HILFR05F	2
10mm Strut Trim Packer	(Nitro Gas / Foam Cell)	HILFR10 / HILFR10F	2
15mm Strut Trim Packer	(Nitro Gas / Foam Cell)	HILFR15 / HILFR15F	2

• ONLY Compatible with Ironman 4x4 Struts (except Pro), lift height subject to 1:2 motion ratio. Unnecessary fitment may lift vehicle too high

REAR SUSPENSION

SHOCK ABSORBER

Nitro Gas Comfort	12636GRC	2
Nitro Gas	12636GR	2
Foam Cell Comfort	24636FEC	2
Foam Cell	24636FE	2

LEAF SPRING	Estimated Lift	Additional Load		
Comfort	40mm	0 - 200kg	MITSO41A	2
Performance	40mm	0 - 300kg	MITSO41B	2
Constant Load	40mm	300kg - GVM	MITSO41C	2

• Must use Ironman 4x4 bushes. Unladen manual vehicles with 2 piece tail shaft may experience vibration in first gear

U-BOLTS

U-Bolt Kit	1102UBK	2
------------	----------------	---

POLYURETHANE SPRING BUSHES

Bush Kit	715TUK	1
----------	---------------	---

GREASABLE SHACKLES AND PINS

Greasable Shackle	795	2
Non-Greasable Pin	387-1	2

LOAD PLUS

Load Plus Helper Springs	LP4	1
--------------------------	------------	---

SUSPENSION KIT

Comfort w/ Gas Shocks	MITSO41AKG
Comfort w/ Foam Cell Shocks	MITSO41AKF
Performance w/ Gas Shocks	MITSO41BKG
Performance w/ Foam Cell Shocks	MITSO41BKF
Constant Load w/ Gas Shocks	MITSO41CKG
Constant Load w/ Foam Cell Shocks	MITSO41CKF

• Specify Front Coil Springs when ordering

• Unladen manual vehicles with 2 piece tail shaft may experience vibration in first gear

SUSPENSION KIT CONTENTS

Shock Absorbers	Leaf Springs
Strut Shock Absorbers	U-Bolts
Coil Springs	Polyurethane Spring Bushes



Product	Part No.	Qty Req
---------	----------	---------

FRONT SUSPENSION

SHOCK ABSORBER

Nitro Gas	12082GR	2
Foam Cell	24082FE	2

TORSION BAR

Uprated Torsion Bars	1278mm Length	MITS013	1
Uprated Torsion Bars	1308mm Length	MITS019	1

- Check Torsion Bar length before ordering
- Minimum 60mm downward suspension travel required

STEERING DAMPER

Foam Cell	Suits vehicles w/o power steering	3517	1
-----------	-----------------------------------	-------------	---

REAR SUSPENSION

SHOCK ABSORBER

Nitro Gas Comfort	12636GRC	2
Nitro Gas	12636GR	2
Foam Cell Comfort	24636FEC	2
Foam Cell	24636FE	2

LEAF SPRING

Estimated Lift

Additional Load

Performance	45mm	0 - 300kg	MITS018B	2
Constant Load	45mm	300kg - GVM	MITS018C	2

- Must use Ironman 4x4 bushes

U-BOLTS

U-Bolt Kit	451UBK	2
------------	---------------	---

POLYURETHANE SPRING BUSHES

Bush Kit	715UK	1
----------	--------------	---

GREASABLE SHACKLES AND PINS

Greasable Shackle	795	2
Greasable Pin	796	2

LOAD PLUS

Load Plus Helper Springs	LP4	1
--------------------------	------------	---

SUSPENSION KIT

Performance w/ Gas Shocks	MITS018BKG1
Performance w/ Foam Cell Shocks	MITS018BKF1
Constant Load w/ Gas Shocks	MITS018CKG1
Constant Load w/ Foam Cell Shocks	MITS018CKF1

- Check Torsion Bar length before ordering

SUSPENSION KIT CONTENTS

Shock Absorbers	U-Bolts
Leaf Springs	Polyurethane Spring Bushes
Torsion Bars	

PAJERO

Montero NH-NL (Leaf)
1991-1999



Product

Part No.

Qty Req

FRONT SUSPENSION

SHOCK ABSORBER

Nitro Gas		12087GR	2
Foam Cell		24087FE	2

TORSION BAR

Uprated Torsion Bars	1278mm Length	MITS013	1
Uprated Torsion Bars	1308mm Length	MITS019	1

- Check Torsion Bar length before ordering
- Minimum 60mm downward suspension travel required

STEERING DAMPER

Foam Cell	Suits vehicles w/o power steering	3517	1
-----------	-----------------------------------	-------------	---

REAR SUSPENSION

SHOCK ABSORBER

Nitro Gas Comfort		12636GRC	2
Nitro Gas		12636GR	2
Foam Cell Comfort		24636FEC	2
Foam Cell		24636FE	2

LEAF SPRING

Estimated Lift

Additional Load

Performance	40mm	0 - 300kg	MITS018B	2
Constant Load	40mm	300kg - GVM	MITS018C	2

- Must use Ironman 4x4 bushes

U-BOLTS

U-Bolt Kit	451UBK	2
------------	---------------	---

POLYURETHANE SPRING BUSHES

Bush Kit	715TUK	1
----------	---------------	---

GREASABLE SHACKLES AND PINS

Greasable Shackle	795	2
Greasable Pin	796	2

LOAD PLUS

Load Plus Helper Springs	LP4	1
--------------------------	------------	---

SUSPENSION KIT

Performance w/ Gas Shocks	MITS018BKG2
Performance w/ Foam Cell Shocks	MITS018BKF2
Constant Load w/ Gas Shocks	MITS018CKG2
Constant Load w/ Foam Cell Shocks	MITS018CKF2

- Check Torsion Bar length before ordering

SUSPENSION KIT CONTENTS

Shock Absorbers	U-Bolts
Leaf Springs	Polyurethane Spring Bushes
Torsion Bars	



Product	Part No.	Qty Req
---------	----------	---------

FRONT SUSPENSION

SHOCK ABSORBER

Nitro Gas	12082GR	2
Foam Cell	24082FE	2

TORSION BAR

Uprated Torsion Bars	1278mm Length	MITS013	1
Uprated Torsion Bars	1308mm Length	MITS019	1

- Check Torsion Bar length before ordering
- Minimum 60mm downward suspension travel required

STEERING DAMPER

Foam Cell	Suits vehicles w/o power steering	3517	1
-----------	-----------------------------------	-------------	---

REAR SUSPENSION

SHOCK ABSORBER

Nitro Gas Comfort	12645GRC	2
Nitro Gas	12645GR	2
Foam Cell Comfort	24645FEC	2
Foam Cell	24645FE	2

COIL SPRINGS

Estimated Lift

Additional Load

Performance SWB	40mm	0 - 200kg	MITS022B	1
Performance LWB	40mm	0 - 200kg	MITS020B	1
Constant Load	40mm	200kg - GVM	MITS020C	1

SUSPENSION KIT

Performance SWB w/ Gas Shocks	MITS022BKG1
Performance SWB w/ Foam Cell Shocks	MITS022BKF1
Performance LWB w/ Gas Shocks	MITS020BKG1
Performance LWBw/ Foam Cell Shocks	MITS020BKF1
Constant Load w/ Gas Shocks	MITS020CKG1
Constant Load w/ Foam Cell Shocks	MITS020CKF1

- Check Torsion Bar length before ordering

SUSPENSION KIT CONTENTS

Shock Absorbers	Coil Springs
-----------------	--------------

PAJERO

Montero NH-NL (Coil)
6/1991-2000



Product	Part No.	Qty Req
---------	----------	---------

FRONT SUSPENSION

SHOCK ABSORBER

Nitro Gas	12087GR	2
Foam Cell	24087FE	2

TORSION BAR

Uprated Torsion Bars	1278mm Length	MITS013	1
Uprated Torsion Bars	1308mm Length	MITS019	1

- Check Torsion Bar length before ordering
- Minimum 60mm downward suspension travel required

STEERING DAMPER

Foam Cell	Suits vehicles w/o power steering	3517	1
-----------	-----------------------------------	-------------	---

REAR SUSPENSION

SHOCK ABSORBER

Nitro Gas	12646GR	2
Foam Cell	24646FE	2

COIL SPRINGS

	Estimated Lift	Additional Load		
Performance SWB	40mm	0 - 200kg	MITS022B	1
Performance LWB	40mm	0 - 200kg	MITS020B	1
Constant Load	40mm	200kg - GVM	MITS020C	1

SUSPENSION KIT

Performance SWB w/ Gas Shocks	MITS022BKG2
Performance SWB w/ Foam Cell Shocks	MITS022BKF2
Performance LWB w/ Gas Shocks	MITS020BKG2
Performance LWBw/ Foam Cell Shocks	MITS020BKF2
Constant Load w/ Gas Shocks	MITS020CKG2
Constant Load w/ Foam Cell Shocks	MITS020CKF2

- Check Torsion Bar length before ordering

SUSPENSION KIT CONTENTS

Shock Absorbers	Torsion Bars
Coil Springs	



Product	Part No.	Qty Req
---------	----------	---------

FRONT SUSPENSION

SHOCK ABSORBER

Nitro Gas Strut	12713GR	2
Foam Cell Strut	24713FE	2

COIL SPRINGS **Estimated Lift** **Additional Load**

Performance	40mm	0 - 50kg	MITS038B	1
Constant Load or Diesel	40mm	50 - 100kg	MITS038C	1

REAR SUSPENSION

SHOCK ABSORBER

Nitro Gas	12714GR	2
-----------	----------------	---

COIL SPRINGS **Estimated Lift** **Additional Load**

Performance SWB	40mm	0 - 200kg	MITS039A	1
Performance LWB	40mm	0 - 200kg	MITS039B	1
Constant Load	40mm	200kg - GVM	MITS039C	1

SUSPENSION KIT

Performance SWB w/ Gas Shocks	MITS038AKG
Performance LWB Petrol w/ Gas Shocks	MITS038BKG
Performance LWB Diesel w/ Gas Shocks	MITS038CKG
Constant Load LWB Petrol w/ Gas Shocks	MITS038CKG1
Constant Load LWB Diesel w/ Gas Shocks	MITS038CKG2

- Vehicles with Monocoque body construction can be subject to increased NVH (Noise) with upgraded suspension installed
- Vehicles with independent suspension must maintain a minimum of 60mm downward suspension travel
- Mandatory 4 wheel alignment after installing new suspension

SUSPENSION KIT CONTENTS

Shock Absorbers	Coil Springs
Strut Shock Absorbers	

CHALLENGER

Montero Sport PA (Leaf)
1998-2006



Product	Part No.	Qty Req
---------	----------	---------

FRONT SUSPENSION

SHOCK ABSORBER

Nitro Gas	12087GR	2
Foam Cell	24087FE	2

TORSION BAR

Up-rated Torsion Bars	MITSO19	1
-----------------------	---------	---

• Minimum 60mm downward suspension travel required

REAR SUSPENSION

SHOCK ABSORBER

Nitro Gas Comfort	12636GRC	2
Nitro Gas	12636GR	2
Foam Cell Comfort	24636FEC	2
Foam Cell	24636FE	2

LEAF SPRINGS

	Estimated Lift	Additional Load		
Performance	40mm	0 - 300kg	MITSO18B	2
Constant Load	40mm	300kg - GVM	MITSO18C	2

• Must use Ironman 4x4 bushes

U-BOLTS

U-Bolt Kit	451UBK	2
------------	--------	---

POLYURETHANE SPRING BUSHES

Bush Kit	715STUK	1
----------	---------	---

GREASABLE SHACKLES AND PINS

Greasable Shackle	795	2
Greasable Pin	796	2

LOAD PLUS

Load Plus Helper Springs	LP4	1
--------------------------	-----	---

SUSPENSION KIT

Performance w/ Gas Shocks	MITSO18BKG
Performance w/ Foam Cell Shocks	MITSO18BKF
Constant Load w/ Gas Shocks	MITSO18CKG
Constant Load w/ Foam Cell Shocks	MITSO18CKF

SUSPENSION KIT CONTENTS

Shock Absorbers	U-Bolts
Leaf Springs	Polyurethane Spring Bushes
Torsion Bars	



CHALLENGER

Montero Sport PA (Coil)

1998-2008

MITSUBISHI

Product

Part No.

Qty Req

FRONT SUSPENSION

SHOCK ABSORBER

Nitro Gas	12087GR	2
Foam Cell	24087FE	2

TORSION BAR

Upated Torsion Bars	MITS019	1
---------------------	----------------	---

• Minimum 60mm downward suspension travel required

REAR SUSPENSION

SHOCK ABSORBER

Nitro Gas Comfort	12645GRC	2
Nitro Gas	12645GR	2
Foam Cell Comfort	24645FEC	2
Foam Cell	24645FE	2

COIL SPRINGS

Estimated Lift

Additional Load

Performance	40mm	0 - 200kg	MITS022B	1
Constant Load	40mm	200-400kg	MITS020B	1
Extra Constant Load	40mm	400kg - GVM	MITS020C	1

SUSPENSION KIT

Performance w/ Gas Shocks	MITS022BKG
Performance w/ Foam Cell Shocks	MITS022BKF
Constant Load w/ Gas Shocks	MITS020BKG
Constant Load w/ Foam Cell Shocks	MITS020BKF
Extra Constant Load w/ Gas Shocks	MITS020CKG
Extra Constant Load w/ Foam Cell	MITS020CKF

SUSPENSION KIT CONTENTS

Shock Absorbers	Torsion Bars
Coil Springs	

CHALLENGER

Pajero Sport / Montero Sport / Dakar PB
2009+



Product	Part No.	Qty Req
---------	----------	---------

FRONT SUSPENSION

SHOCK ABSORBER

Nitro Gas Strut	12715GR	2
Foam Cell Strut	24715FE	2

• Height adjustable with Ironman 4x4 Strut Trim Packers

COIL SPRINGS	Estimated Lift	Additional Load		
Standard	0mm	0 - 50kg	MITS040S	1
Comfort	35mm	0 - 50kg	MITS040A	1
Performance	40mm	0 - 80kg	MITS040B	1
Constant Load	40mm	80 - 110kg	MITS040C	1

TRIM PACKERS

5mm Strut Trim Packer	(Nitro Gas / Foam Cell)	HILFR05 / HILFR05F	2
10mm Strut Trim Packer	(Nitro Gas / Foam Cell)	HILFR10 / HILFR10F	2
15mm Strut Trim Packer	(Nitro Gas / Foam Cell)	HILFR15 / HILFR15F	2

• ONLY Compatible with Ironman 4x4 Struts (except Pro), lift height subject to 1:2 motion ratio. Unnecessary fitment may lift vehicle too high

REAR SUSPENSION

SHOCK ABSORBER

Nitro Gas Comfort	12645GRC	2
Nitro Gas	12645GR	2
Foam Cell Comfort	24645FEC	2
Foam Cell	24645FE	2

COIL SPRING	Estimated Lift	Additional Load		
Standard	0mm	0 - 250kg	MITS042S	1
Comfort	20mm	0 - 250kg	MITS042A	1
Performance	40mm	0 - 250kg	MITS042B	1
Constant Load	40mm	250kg - GVM	MITS042C	1

SUSPENSION KIT

Standard w/ Gas Shocks	MITS042SKG
Standard w/ Foam Cell Shocks	MITS042SKF
Comfort w/ Gas Shocks	MITS042AKG
Comfort w/ Foam Cell Shocks	MITS042AKF
Performance w/ Gas Shocks	MITS042BKG
Performance w/ Foam Cell Shocks	MITS042BKF
Constant Load w/ Gas Shocks	MITS042CKG
Constant Load w/ Foam Cell Shocks	MITS042CKF

• Specify Front Coil Springs when ordering

SUSPENSION KIT CONTENTS

Shock Absorbers	Coil Springs
Strut Shock Absorbers	



PAJERO

iO Pinin
1999+

MITSUBISHI

Product **Part No.** **Qty Req**

FRONT SUSPENSION

COIL SPRINGS	Estimated Lift	Additional Load		
Performance	35mm	0 - 50kg	MITS034B	1

CAMBER CORRECTION

Camber Bolt Kit			ICAMBER14	1
-----------------	--	--	------------------	---

REAR SUSPENSION

COIL SPRINGS	Estimated Lift	Additional Load		
Performance	35mm	0 - 200kg	MITS035B	1

DELICA

L400
1994+



Product

Part No.

Qty Req

FRONT SUSPENSION

SHOCK ABSORBER

Nitro Gas	12667GR	2
Foam Cell	24667FE	2

TORSION BAR

Upated Torsion Bars	MITSO31	1
---------------------	----------------	---

- Torsion Bars suit vehicles 5/1994-5/1999 only
- Minimum 60mm downward suspension travel required

REAR SUSPENSION

SHOCK ABSORBER

Nitro Gas	Without ECS	12698GR	2
Nitro Gas	With ECS	12671GR	2

- ECS - Electronic Control Suspension

COIL SPRINGS

Estimated Lift

Additional Load

Performance	40mm	0 - 250kg	MITSO25B	1
-------------	------	-----------	-----------------	---

SUSPENSION KIT

Performance w/ Gas Shocks without ECS	MITSO31BKG
Performance w/ Gas Shocks with ECS	MITSO31BKG1

- Shock Absorbers do not re-connect to ECS system

SUSPENSION KIT CONTENTS

Shock Absorbers	Torsion Bars
Coil Springs	



PATROL

MQ G160 (Round Headlights)
Pre 1984

NISSAN

Product

Part No.

Qty Req

FRONT SUSPENSION

SHOCK ABSORBER

Nitro Gas **12075GR** 2

LEAF SPRINGS

Estimated Lift

Additional Load

Drivers side 45mm 0 - 50kg **NISS003BD/S** 1

Near Side 45mm 0 - 50kg **NISS003BN/S** 1

STEERING DAMPER

Foam Cell **3522** 1

U-BOLTS

U-Bolt Kit Driver's side **452UBK** 1

U-Bolt Kit Near side **451UBK** 1

STEEL SPRING BUSHES

Bush Kit **721UK** 1

GREASABLE SHACKLES AND PINS

Greasable Shackle Straight Side Plates **355K** 2

Greasable Pin **470** 2

REAR SUSPENSION

SHOCK ABSORBER

Nitro Gas **12076GR** 2

LEAF SPRINGS

Estimated Lift

Additional Load

Drivers side 45mm 0 - 200kg **NISS004BD/S** 1

Near Side 45mm 0 - 200kg **NISS004BN/S** 1

U-BOLTS

U-Bolt Kit **453UBK** 2

POLYURETHANE SPRING BUSHES

Bush Kit **722UK** 1

GREASABLE SHACKLES AND PINS

Greasable Shackle **664** 2

Greasable Pin **470** 2

LOAD PLUS

Load Plus Helper Springs **LP3** 1

SUSPENSION KIT

Performance w/ Gas Shocks **NISS003BKG**

SUSPENSION KIT CONTENTS

Shock Absorbers U-Bolts
Leaf Springs Polyurethane Spring Bushes

PATROL

MK G160 (Rectangle Headlights)
1984+



Product

Part No.

Qty Req

FRONT SUSPENSION

SHOCK ABSORBER

Nitro Gas **12075GR** 2

LEAF SPRINGS

Estimated Lift Additional Load

Drivers side 45mm 0 - 50kg **NISS005BD/S** 1
Near Side 45mm 0 - 50kg **NISS005BN/S** 1

STEERING DAMPER

Foam Cell **3522** 1

U-BOLTS

U-Bolt Kit Drivers side **452UBK** 1
U-Bolt Kit Near side **451UBK** 1

POLYURETHANE SPRING BUSHES

Bush Kit **724UK** 1

GREASABLE SHACKLES AND PINS

Greasable Shackle Stepped Side Plates **665** 2
Greasable Pin **470** 2

REAR SUSPENSION

SHOCK ABSORBER

Nitro Gas **12076GR** 2

LEAF SPRINGS

Estimated Lift Additional Load

Drivers side 45mm 0 - 200kg **NISS004BD/S** 1
Near Side 45mm 0 - 200kg **NISS004BN/S** 1

U-BOLTS

U-Bolt Kit **453UBK** 2

POLYURETHANE SPRING BUSHES

Bush Kit **722UK** 1

GREASABLE SHACKLES AND PINS

Greasable Shackle **664** 2
Greasable Pin **470** 2

LOAD PLUS

Load Plus Helper Springs **LP3** 1

SUSPENSION KIT

Performance w/ Gas Shocks **NISS005BKG**

SUSPENSION KIT CONTENTS

Shock Absorbers U-Bolts
Leaf Springs Polyurethane Spring Bushes

FOAMCELL PRO BIG LIFT SUSPENSION KITS



**Fully integrated
4" and 6" lifts
to suit Nissan
Patrol GQ/GU**

Kits Include

- Coil Springs
- Foam Cell Pro Shock Absorbers
- Adjustable Panhard Rods
- Adjustable Trailing Arms
- Caster Correction Plates
- Extended Sway Bar Links
- Extended Brake Hoses

Kit components are also available individually



Nissan Patrol GQ/GU

**4" and 6" lifts are designed for off-road competition use.
Certification may be required for on-road use.**



Product	Part No.	Qty Req
---------	----------	---------

FRONT SUSPENSION**SHOCK ABSORBER**

Nitro Gas		12091GR	2
Foam Cell		24091FE	2
Foam Cell	Suits 5" Lift	24091LFE	2
Foam Cell	Suits 7" Lift	24091LFE1	2
Foam Cell Pro		45091FE	2
Foam Cell Pro	Suits 5" Lift	45091LFE	2
Foam Cell Pro	Suits 7" Lift	45091LFE1	2

COIL SPRINGS

	Estimated Lift	Additional Load		
Performance	50mm	0 - 50kg	NISS007B	1
Constant Load	50mm	50 - 110kg	NISS009B	1
Performance 5" Lift	125mm	0 - 100kg	NISS026B	1
Performance 7" Lift	175mm	0 - 100kg	NISS043B	1

STEERING DAMPER

Foam Cell	Pre 8/1989	3534	1
Foam Cell	8/1989+	3536	1

CASTER CORRECTION

2° Offset Bush Kit	1144SK	1
5° Offset Plate Kit	CPLATE003	1

CROSSMEMBER SPACER

6mm / 12mm Spacer Kit	1002K	1
-----------------------	--------------	---

DRAG LINK

Adjustable Drag Link	ADL003	1
----------------------	---------------	---

ADJUSTABLE PANHARD ROD

Right Hand Drive Rod	PANHARD003	1
Left Hand Drive Rod	PANHARD008	1

SWAY BAR LINK

Extended Sway Bar Link	Suits 1-3" Lift	SBEXT006	2
Extended Sway Bar Link	Suits 4-7" Lift	SBEXT003	2

COIL SPACER

Polyurethane 15mm	Provides 10mm Lift	PATF15	2
Polyurethane 30mm	Provides 25mm Lift	PATF30	2

BRAKE HOSE

Extended Brake Hose	BHOSE003	1
---------------------	-----------------	---

REAR SUSPENSION**SHOCK ABSORBER**

Nitro Gas		12094GR	2
Foam Cell		24094FE	2
Foam Cell	Suits 5" Lift	24094LFE	2
Foam Cell	Suits 7" Lift	24094LFE1	2
Foam Cell Pro		45094FE	2
Foam Cell Pro	Suits 5" Lift	45094LFE	2
Foam Cell Pro	Suits 7" Lift	45094LFE1	2

COIL SPRINGS

	Estimated Lift	Additional Load		
Performance	50mm	0 - 200kg	NISS008B	1
Constant Load	50mm	200 - 400kg	NISS010B	1
Extra Constant Load	55mm	400kg - GVM	NISS010C	1
Performance 5" Lift	125mm	0 - 300kg	NISS027B	1
Performance 7" Lift	175mm	0 - 300kg	NISS044B	1

CONTINUED NEXT PAGE



Listing Continued

Product		Part No.	Qty Req
PANHARD ROD			
Adjustable Panhard Rod		PANHARD004	1
ADJUSTABLE TRAILING ARM			
Upper Trailing Arm		UTA003	2
Lower Trailing Arm		LTA003	2
SWAY BAR LINK			
Extended Sway Bar Link	Suits 1-3" Lift	SBEXT006	2
Extended Sway Bar Link	Suits 4-7" Lift	SBEXT003	2
COIL SPACER			
Polyurethane 15mm	Provides 10mm Lift	PATR15	2
Polyurethane 30mm	Provides 25mm Lift	PATR30	2
BRAKE HOSE			
Extended Brake Hose		BHOSE004	1
BUSH KIT			
Suspension Arm Bush Kit	Pre 8/1989	831K	1
Suspension Arm Bush Kit	8/1989+	839K	1

SUSPENSION KIT

Performance w/ Gas Shocks	NISS007BKG
Performance w/ Foam Cell Shocks	NISS007BKF
Performance w/ Foam Cell Pro Shocks	NISS007BKP
Constant Load w/ Gas Shocks	NISS009BKG
Constant Load w/ Foam Cell Shocks	NISS009BKF
Constant Load w/ Foam Cell Pro Shocks	NISS009BKP
Extra Constant Load w/ Gas Shocks	NISS009BKG1
Extra Constant Load w/ Foam Cell Shocks	NISS009BKF1
Extra Constant Load w/ Foam Cell Pro Shocks	NISS009BKP1
Performance RHD w/ Foam Cell Shocks 5" Lift	NISS026BKF
Performance RHD w/ Foam Cell Pro Shocks 5" Lift	NISS026BKP
Performance RHD w/ Foam Cell Shocks 7" Lift	NISS043BKF
Performance RHD w/ Foam Cell Pro Shocks 7" Lift	NISS043BKP
Performance LHD w/ Foam Cell Shocks 5" Lift	NISS026BKFL
Performance LHD w/ Foam Cell Pro Shocks 5" Lift	NISS026BKPL
Performance LHD w/ Foam Cell Shocks 7" Lift	NISS043BKFL
Performance LHD w/ Foam Cell Pro Shocks 7" Lift	NISS043BKPL

• 5" and 7" lifts may not be legal for on-road use in your area, certification may be required for on-road use

• Due to the extreme nature of 5" and 7" lifts, further modifications may be required, and will vary between vehicles

Such modifications are entirely the owners responsibility. Ironman 4x4 accept no responsibility for any damage or injury caused by use of these products

50MM SUSPENSION KIT CONTENTS

Shock Absorbers
Coil Springs

5" AND 7" SUSPENSION KIT CONTENTS

Shock Absorbers
Coil Springs
Panhard Rods

Sway Bar Links
Caster Plates
Brake Hoses

Adjustable Trailing Arms

PATROLGQ Y60 LWB Wagon
1988-1998**Product****Part No.****Qty Req****FRONT SUSPENSION****SHOCK ABSORBER**

Nitro Gas			12091GR	2
Foam Cell			24091FE	2
Foam Cell	Suits 4" Lift		24091LFE	2
Foam Cell	Suits 6" Lift		24091LFE1	2
Foam Cell Pro			45091FE	2
Foam Cell Pro	Suits 4" Lift		45091LFE	2
Foam Cell Pro	Suits 6" Lift		45091LFE1	2

COIL SPRINGS**Estimated Lift****Additional Load**

Performance	50mm	0 - 50kg	NISS009B	1
Constant Load	50mm	50 - 110kg	NISS009C	1
Performance 4" Lift	100mm	0 - 100kg	NISS026B	1
Performance 6" Lift	150mm	0 - 100kg	NISS043B	1

STEERING DAMPER

Foam Cell	Pre 8/1989		3534	1
Foam Cell	8/1989+		3536	1

CASTER CORRECTION

2° Offset Bush Kit			1144SK	1
5° Offset Plate Kit			CPLATE003	1

CROSSMEMBER SPACER

6mm / 12mm Spacer Kit			1002K	1
-----------------------	--	--	--------------	---

DRAG LINK

Adjustable Drag Link			ADL003	1
----------------------	--	--	---------------	---

ADJUSTABLE PANHARD ROD

Right Hand Drive Rod			PANHARD003	1
Left Hand Drive Rod			PANHARD008	1

SWAY BAR LINK

Extended Sway Bar Link	Suits 1-3" Lift		SBEXT006	2
Extended Sway Bar Link	Suits 4-7" Lift		SBEXT003	2

COIL SPACER

Polyurethane 15mm	Provides 10mm Lift		PATF15	2
Polyurethane 30mm	Provides 25mm Lift		PATF30	2

BRAKE HOSE

Extended Brake Hose			BHOSE003	1
---------------------	--	--	-----------------	---

REAR SUSPENSION**SHOCK ABSORBER**

Nitro Gas			12094GR	2
Foam Cell			24094FE	2
Foam Cell	Suits 4" Lift		24094LFE	2
Foam Cell	Suits 6" Lift		24094LFE1	2
Foam Cell Pro			45094FE	2
Foam Cell Pro	Suits 4" Lift		45094LFE	2
Foam Cell Pro	Suits 6" Lift		45094LFE1	2

CONTINUED NEXT PAGE



Product	Part No.	Qty Req
---------	----------	---------

COIL SPRINGS

Product	Estimated Lift	Additional Load	Part No.	Qty Req
Performance	50mm	0 - 200kg	NISS010B	1
Constant Load	50mm	200 - 400kg	NISS010C	1
Extra Constant Load	50mm	400 - 600kg	NISS020C	1
Extra Heavy Constant Load	50mm	600kg - GVM	NISS020D	1
Performance 4" Lift	100mm	0 - 300kg	NISS027B	1
Performance 6" Lift	150mm	0 - 300kg	NISS044B	1

PANHARD ROD

Adjustable Panhard Rod			PANHARD004	1
------------------------	--	--	------------	---

ADJUSTABLE TRAILING ARM

Upper Trailing Arm			UTA003	2
Lower Trailing Arm			LTA003	2

SWAY BAR LINK

Extended Sway Bar Link	Suits 1-3" Lift		SBEXT006	2
Extended Sway Bar Link	Suits 4-7" Lift		SBEXT003	2

COIL SPACER

Polyurethane 15mm	Provides 10mm Lift		PATR15	2
Polyurethane 30mm	Provides 25mm Lift		PATR30	2

BRAKE HOSE

Extended Brake Hose			BHOSE004	1
---------------------	--	--	----------	---

BUSH KIT

Suspension Arm Bush Kit	Pre 8/1989		831K	1
Suspension Arm Bush Kit	8/1989+		839K	1

SUSPENSION KIT

Performance w/ Gas Shocks			NISS009BKG	
Performance w/ Foam Cell Shocks			NISS009BKF	
Performance w/ Foam Cell Pro Shocks			NISS009BKP	
Constant Load w/ Gas Shocks			NISS009CKG	
Constant Load w/ Foam Cell Shocks			NISS009CKF	
Constant Load w/ Foam Cell Pro Shocks			NISS009CKP	
Extra Constant Load w/ Gas Shocks			NISS020CKG	
Extra Constant Load w/ Foam Cell Shocks			NISS020CKF	
Extra Constant Load w/ Foam Cell Pro Shocks			NISS020CKP	
Extra Heavy Constant Load w/ Gas Shocks			NISS024DKG	
Extra Heavy Constant Load w/ Foam Cell Shocks			NISS024DKF	
Extra Heavy Constant Load w/ Foam Cell Pro Shocks			NISS024DKP	
Performance RHD w/ Foam Cell Shocks 4" Lift			NISS026BKF	
Performance RHD w/ Foam Cell Pro Shocks 4" Lift			NISS026BKP	
Performance RHD w/ Foam Cell Shocks 6" Lift			NISS043BKF	
Performance RHD w/ Foam Cell Pro Shocks 6" Lift			NISS043BKP	
Performance LHD w/ Foam Cell Shocks 4" Lift			NISS026BKFL	
Performance LHD w/ Foam Cell Pro Shocks 4" Lift			NISS026BKPL	
Performance LHD w/ Foam Cell Shocks 6" Lift			NISS043BKFL	
Performance LHD w/ Foam Cell Pro Shocks 6" Lift			NISS043BKPL	

- 4" and 6" lifts may not be legal for on-road use in your area, certification may be required for on-road use
 - Due to the extreme nature of 4" and 6" lifts, further modifications may be required, and will vary between vehicles
- Such modifications are entirely the owners responsibility. Ironman 4x4 accept no responsibility for any damage or injury caused by use of the these products

50MM SUSPENSION KIT CONTENTS

Shock Absorbers
Coil Springs

4" AND 6" SUSPENSION KIT CONTENTS

Shock Absorbers
Coil Springs
Panhard Rods
Sway Bar Links
Caster Plates
Brake Hoses
Adjustable Trailing Arms

PATROLGQ Y60 Cab Chassis (Leaf / Leaf)
1988+

Product	Part No.	Qty Req
---------	----------	---------

FRONT SUSPENSION**SHOCK ABSORBER**

Nitro Gas	12661GR	2
Foam Cell	24661FE	2

LEAF SPRINGS

	Estimated Lift	Additional Load		
Drivers side	50mm	0 - 110kg	NISS011CD/S	1
Near side	50mm	0 - 110kg	NISS011CN/S	1

STEERING DAMPER

Foam Cell	3522	1
-----------	------	---

U-BOLTS

Drivers Side U-Bolt Kit	669UBK	1
Near Side U-Bolt Kit	436UBK	1

POLYURETHANE SPRING BUSHES

Bush Kit	718UK	1
----------	-------	---

GREASABLE SHACKLES AND PINS

Greasable Shackle	Left Hand Side	353RH	1
Greasable Shackle	Right Hand Side	353LH	1
Greasable Pin		667	2

REAR SUSPENSION**SHOCK ABSORBER**

Nitro Gas	12648GR	2
Foam Cell	24648FE	2

LEAF SPRINGS

	Estimated Lift	Additional Load		
Constant Load Drivers Side	50mm	0 - 400kg	NISS012CD/S	1
Constant Load Near Side	50mm	0 - 400kg	NISS012CN/S	1
Extra Constant Load Drivers	50mm	400kg - GVM	NISS012DD/S	1
Extra Constant Load Near	50mm	400kg - GVM	NISS012DN/S	1

U-BOLTS

U-Bolt Kit	670UBK	2
------------	--------	---

POLYURETHANE SPRING BUSHES

Bush Kit	719UK	1
----------	-------	---

GREASABLE SHACKLES AND PINS

Greasable Shackle	Left Hand Side	353LH	1
Greasable Shackle	Right Hand Side	353RH	1
Greasable Pin		667	2

LOAD PLUS

Load Plus Helper Springs	LP4	1
--------------------------	-----	---

SUSPENSION KIT

Constant Load w/ Gas Shocks	NISS011CKG
Constant Load w/ Foam Cell	NISS011CKF
Extra Constant Load w/ Gas Shocks	NISS011DKG
Extra Constant Load w/ Foam Cell	NISS011DKF

SUSPENSION KIT CONTENTS

Shock Absorbers	U-Bolts
Leaf Springs	Polyurethane Spring Bushes



Product	Part No.	Qty Req
---------	----------	---------

FRONT SUSPENSION

SHOCK ABSORBER

Nitro Gas	12091GR	2
Foam Cell	24091FE	2

COIL SPRINGS **Estimated Lift** **Additional Load**

Performance	50mm	0 - 50kg	NISS024B	1
Constant Load	50mm	50 - 110kg	NISS009C	1

STEERING DAMPER

Foam Cell	3511	1
-----------	------	---

CASTER CORRECTION

2° Offset Bush Kit	1144SK	1
5° Offset Plate Kit	CPLATE003	1

ADJUSTABLE DRAG LINK

Drag Link	ADL003	1
-----------	--------	---

ADJUSTABLE PANHARD ROD

Right Hand Drive Rod	PANHARD003	1
Left Hand Drive Rod	PANHARD008	1

SWAY BAR LINK

Extended Sway Bar Link	Suits 1-3" Lift	SBEXT006	2
------------------------	-----------------	----------	---

COIL SPACER

Polyurethane 15mm	Provides 10mm Lift	PATF15	2
Polyurethane 30mm	Provides 25mm Lift	PATF30	2

BRAKE HOSE

Extended Brake Hose	Non ABS Models	BHOSE003	1
Extended Brake Hose	ABS models	BHOSE005	2

REAR SUSPENSION

SHOCK ABSORBER

Nitro Gas	12648GR	2
Foam Cell	24648FE	2

LEAF SPRINGS **Estimated Lift** **Additional Load**

Constant Load Drivers Side	50mm	0 - 400kg	NISS012CD/S	1
Constant Load Near Side	50mm	0 - 400kg	NISS012CN/S	1
Extra Constant Load Drivers	50mm	400kg - GVM	NISS012DD/S	1
Extra Constant Load Near	50mm	400kg - GVM	NISS012DN/S	1

U-BOLTS

U-Bolt Kit		1100UBK	2	
U-Bolt Kit	Extra Long	Suits NISS012D Springs	1100UBKL	2

POLYURETHANE SPRING BUSHES

Bush Kit	719UK	1
----------	-------	---

GREASABLE SHACKLES AND PINS

Greasable Shackle	Left Hand Side	353LH	1
Greasable Shackle	Right Hand Side	353RH	1
Greasable Pin		667	2

LOAD PLUS

Load Plus Helper Springs	LP4	1
--------------------------	-----	---

SUSPENSION KIT

Constant Load w/ Gas Shocks	NISS036CKG
Constant Load w/ Foam Cell Shocks	NISS036CKF
Extra Constant Load w/ Gas Shocks	NISS036DKG
Extra Constant Load w/ Foam Cell Shocks	NISS036DKF

SUSPENSION KIT CONTENTS

Shock Absorbers	Ubolts
Coil Springs	Polyurethane Spring Bushes
Leaf Springs	



Product

Part No.

Qty Req

FRONT SUSPENSION**SHOCK ABSORBER**

Nitro Gas			12091GR	2
Foam Cell			24091FE	2
Foam Cell	Suits 4" Lift		24091LFE	2
Foam Cell	Suits 6" Lift		24091LFE1	2
Foam Cell Pro			45091FE	2
Foam Cell Pro	Suits 4" Lift		45091LFE	2
Foam Cell Pro	Suits 6" Lift		45091LFE1	2

COIL SPRINGS**Estimated Lift****Additional Load**

Performance	50mm	0 - 50kg	NISS024B	1
Constant Load	50mm	50 - 110kg	NISS009C	1
Performance 4" Lift	100mm	0 - 100kg	NISS026B	1
Performance 6" Lift	150mm	0 - 100kg	NISS043B	1

STEERING DAMPER

Foam Cell			3511	1
-----------	--	--	-------------	---

CASTER CORRECTION

2° Offset Bush Kit			1144SK	1
5° Offset Plate Kit			CPLATE003	1

DRAG LINK

Adjustable Drag Link			ADL003	1
----------------------	--	--	---------------	---

ADJUSTABLE PANHARD ROD

Right Hand Drive Rod			PANHARD003	1
Left Hand Drive Rod			PANHARD008	1

SWAY BAR LINK

Extended Sway Bar Link	Suits 1-3" Lift		SBEXT006	2
Extended Sway Bar Link	Suits 4-7" Lift		SBEXT003	2

COIL SPACER

Polyurethane 15mm	Provides 10mm Lift		PATF15	2
Polyurethane 30mm	Provides 25mm Lift		PATF30	2

BRAKE HOSE

Extended Brake Hose	Non ABS Models		BHOSE003	1
Extended Brake Hose	ABS models		BHOSE005	2

REAR SUSPENSION**SHOCK ABSORBER**

Nitro Gas			12094GR	2
Foam Cell			24094FE	2
Foam Cell	Suits 4" Lift		24094LFE	2
Foam Cell	Suits 6" Lift		24094LFE1	2
Foam Cell Pro			45094FE	2
Foam Cell Pro	Suits 4" Lift		45094LFE	2
Foam Cell Pro	Suits 6" Lift		45094LFE1	2

COIL SPRINGS**Estimated Lift****Additional Load**

Performance	50mm	0 - 300kg	NISS020B	1
Constant Load	50mm	300 - 400kg	NISS020C	1
Extra Constant Load	50mm	400kg - GVM	NISS020D	1
Performance 4" Lift	100mm	0 - 300kg	NISS027B	1
Performance 6" Lift	150mm	0 - 300kg	NISS044B	1

CONTINUED NEXT PAGE



Product	Part No.	Qty Req	
PANHARD ROD			
Adjustable Panhard Rod	PANHARD004	1	
ADJUSTABLE TRAILING ARM			
Upper Trailing Arm	UTA003	2	
Lower Trailing Arm	LTA003	2	
SWAY BAR LINK			
Extended Sway Bar Link	Suits 1-3" Lift Right Side	SBEXT006	1
Extended Sway Bar Link	Suits 4-7" Lift Right Side	SBEXT003	1
Extended Sway Bar Link	Suits 1-3" Lift Left Side	SBEXT007	1
Extended Sway Bar Link	Suits 4-7" Lift Left Side	SBEXT004	1
COIL SPACER			
Polyurethane 15mm	Provides 10mm Lift	PATR15	2
Polyurethane 30mm	Provides 25mm Lift	PATR30	2
BRAKE HOSE			
Extended Brake Hose	BHOSE004	1	
BUSH KIT			
Suspension Arm Bush Kit	839K	1	

SUSPENSION KIT

Performance w/ Gas Shocks	NISS037BKG
Performance w/ Foam Cell Shocks	NISS037BKF
Performance w/ Foam Cell Pro Shocks	NISS037BKP
Constant Load w/ Gas Shocks	NISS037CKG
Constant Load w/ Foam Cell Shocks	NISS037CKF
Constant Load w/ Foam Cell Pro Shocks	NISS037CKP
Extra Constant Load w/ Gas Shocks	NISS037DKG
Extra Constant Load w/ Foam Cell Shocks	NISS037DKF
Extra Constant Load w/ Foam Cell Pro Shocks	NISS037DKP
Performance RHD w/ Foam Cell Shocks 4" Lift	NISS026BKF
Performance RHD w/ Foam Cell Pro Shocks 4" Lift	NISS026BKP
Performance RHD w/ Foam Cell Shocks 6" Lift	NISS043BKF
Performance RHD w/ Foam Cell Pro Shocks 6" Lift	NISS043BKP
Performance LHD w/ Foam Cell Shocks 4" Lift	NISS026BKFL
Performance LHD w/ Foam Cell Pro Shocks 4" Lift	NISS026BKPL
Performance LHD w/ Foam Cell Shocks 6" Lift	NISS043BKFL
Performance LHD w/ Foam Cell Pro Shocks 6" Lift	NISS043BKPL

- Specify ABS / non-ABS brake hoses when ordering suspension kits
 - 4" and 6" lifts may not be legal for on-road use in your area, certification may be required for on-road use
 - Due to the extreme nature of 4" and 6" lifts, further modifications may be required, and will vary between vehicles
- Such modifications are entirely the owners responsibility. Ironman 4x4 accept no responsibility for any damage or injury caused by use of the these products

50MM SUSPENSION KIT CONTENTS

Shock Absorbers
Coil Springs

4" AND 6" SUSPENSION KIT CONTENTS

Shock Absorbers
Coil Springs
Panhard Rods

Sway Bar Links
Caster Plates
Brake Hoses

Adjustable Trailing Arms



Product

Part No.

Qty Req

FRONT SUSPENSION

SHOCK ABSORBER

Nitro Gas			12091GR	2
Foam Cell			24091FE	2
Foam Cell	Suits 4" Lift		24091LFE	2
Foam Cell	Suits 6" Lift		24091LFE1	2
Foam Cell Pro			45091FE	2
Foam Cell Pro	Suits 4" Lift		45091LFE	2
Foam Cell Pro	Suits 6" Lift		45091LFE1	2

COIL SPRINGS

Estimated Lift Additional Load

Performance	50mm	0 - 50kg	NISS024B	1
Constant Load	50mm	50 - 110kg	NISS009C	1
Performance 4" Lift	100mm	0 - 100kg	NISS026B	1
Performance 6" Lift	150mm	0 - 100kg	NISS043B	1

STEERING DAMPER

Foam Cell	Pre 2/2000		3511	1
Foam Cell	2/2000+		3501	1

CASTER CORRECTION

2° Offset Bush Kit			1144SK	1
5° Offset Plate Kit			CPLATE003	1

DRAG LINK

Adjustable Drag Link			ADL005	1
----------------------	--	--	---------------	---

ADJUSTABLE PANHARD ROD

Right Hand Drive Rod	Pre 2/2000		PANHARD003	1
Left Hand Drive Rod	Pre 2/2000		PANHARD008	1
Right Hand Drive Rod	2/2000+		PANHARD005	1
Left Hand Drive Rod	2/2000+		PANHARD009	1

SWAY BAR LINK

Extended Sway Bar Link	Suits 1-3" Lift		SBEXT006	2
Extended Sway Bar Link	Suits 4-7" Lift		SBEXT003	2

COIL SPACER

Polyurethane 15mm	Provides 10mm Lift		PATF15	2
Polyurethane 30mm	Provides 25mm Lift		PATF30	2

BRAKE HOSE

Extended Brake Hose	Non ABS Models		BHOSE003	1
Extended Brake Hose	ABS models		BHOSE005	2

REAR SUSPENSION

SHOCK ABSORBER

Nitro Gas			12094GR	2
Foam Cell			24094FE	2
Foam Cell	Suits 4" Lift		24094LFE	2
Foam Cell	Suits 6" Lift		24094LFE1	2
Foam Cell Pro			45094FE	2
Foam Cell Pro	Suits 4" Lift		45094LFE	2
Foam Cell Pro	Suits 6" Lift		45094LFE1	2

COIL SPRINGS

Estimated Lift Additional Load

Performance	50mm	0 - 200kg	NISS010C	1
Constant Load	50mm	200 - 400kg	NISS020C	1
Extra Constant Load	50mm	400kg - GVM	NISS020D	1
Performance 4" Lift	100mm	0 - 300kg	NISS027B	1
Performance 6" Lift	150mm	0 - 300kg	NISS044B	1

CONTINUED NEXT PAGE



Listing Continued

Product		Part No.	Qty Req
PANHARD ROD			
Adjustable Panhard Rod	Pre 2/2000	PANHARD004	1
Adjustable Panhard Rod	2/2000+	PANHARD006	1
ADJUSTABLE TRAILING ARM			
Upper Trailing Arm		UTA003	2
Lower Trailing Arm		LTA003	2
SWAY BAR LINK			
Extended Sway Bar Link	Suits 1-3" Lift Right Side	SBEXT006	1
Extended Sway Bar Link	Suits 4-7" Lift Right Side	SBEXT003	1
Extended Sway Bar Link	Suits 1-3" Lift Left Side	SBEXT007	1
Extended Sway Bar Link	Suits 4-7" Lift Left Side	SBEXT004	1
COIL SPACER			
Polyurethane 15mm	Provides 10mm Lift	PATR15	2
Polyurethane 30mm	Provides 25mm Lift	PATR30	2
BRAKE HOSE			
Extended Brake Hose		BHOSE004	1
BUSH KIT			
Suspension Arm Bush Kit	Pre 2/2000	839K	1

SUSPENSION KIT

Performance w/ Gas Shocks		NISS024CKG
Performance w/ Foam Cell Shocks		NISS024CKF
Performance w/ Foam Cell Pro Shocks		NISS024CKP
Constant Load w/ Gas Shocks		NISS037CKG
Constant Load w/ Foam Cell Shocks		NISS037CKF
Constant Load w/ Foam Cell Pro Shocks		NISS037CKP
Extra Constant Load w/ Gas Shocks		NISS037DKG
Extra Constant Load w/ Foam Cell Shocks		NISS037DKF
Extra Constant Load w/ Foam Cell Pro Shocks		NISS037DKP
Performance RHD w/ Foam Cell Shocks 4" Lift	Pre 2/2000	NISS026BKF
Performance RHD w/ Foam Cell Pro Shocks 4" Lift	Pre 2/2000	NISS026BKP
Performance RHD w/ Foam Cell Shocks 6" Lift	Pre 2/2000	NISS043BKF
Performance RHD w/ Foam Cell Pro Shocks 6" Lift	Pre 2/2000	NISS043BKP
Performance RHD w/ Foam Cell Shocks 4" Lift	2/2000+	NISS026BKF1
Performance RHD w/ Foam Cell Pro Shocks 4" Lift	2/2000+	NISS026BKP1
Performance RHD w/ Foam Cell Shocks 6" Lift	2/2000+	NISS043BKF1
Performance RHD w/ Foam Cell Pro Shocks 6" Lift	2/2000+	NISS043BKP1
Performance LHD w/ Foam Cell Shocks 4" Lift	Pre 2/2000	NISS026BKFL
Performance LHD w/ Foam Cell Pro Shocks 4" Lift	Pre 2/2000	NISS026BKPL
Performance LHD w/ Foam Cell Shocks 6" Lift	Pre 2/2000	NISS043BKFL
Performance LHD w/ Foam Cell Pro Shocks 6" Lift	Pre 2/2000	NISS043BKPL
Performance LHD w/ Foam Cell Shocks 4" Lift	2/2000+	NISS026BKF1L
Performance LHD w/ Foam Cell Pro Shocks 4" Lift	2/2000+	NISS026BKP1L
Performance LHD w/ Foam Cell Shocks 6" Lift	2/2000+	NISS043BKF1L
Performance LHD w/ Foam Cell Pro Shocks 6" Lift	2/2000+	NISS043BKP1L

- Specify ABS / non-ABS brake hoses when ordering suspension kits
 - 4" and 6" lifts may not be legal for on-road use in your area, certification may be required for on-road use
 - Due to the extreme nature of 4" and 6" lifts, further modifications may be required, and will vary between vehicles
- Such modifications are entirely the owners responsibility. Ironman 4x4 accept no responsibility for any damage or injury caused by use of the these products

50MM SUSPENSION KIT CONTENTS

- Shock Absorbers
- Coil Springs

4" AND 6" SUSPENSION KIT CONTENTS

- Shock Absorbers
- Coil Springs
- Panhard Rods
- Sway Bar Links
- Caster Plates
- Brake Hoses
- Adjustable Trailing Arms



Product

Part No.

Qty Req

FRONT SUSPENSION

SHOCK ABSORBER

Nitro Gas Strut			12740GR	2
Foam Cell Strut			24740FE	2
Foam Cell Pro Strut			45740FE	2

- Height adjustable with Ironman 4x4 Strut Trim Packers
- Non HBMC models only

COIL SPRINGS

Estimated Lift

Additional Load

Comfort	30mm	0 - 50kg	NISS045A	1
Performance	40mm	0 - 50kg	NISS045B	1
Constant Load	50mm	50 - 110kg	NISS045C	1

TRIM PACKERS

5mm Strut Trim Packer	(Nitro Gas / Foam Cell)		HILFR05 / HILFR05F	2
10mm Strut Trim Packer	(Nitro Gas / Foam Cell)		HILFR10 / HILFR10F	2
15mm Strut Trim Packer	(Nitro Gas / Foam Cell)		HILFR15 / HILFR15F	2

- ONLY Compatible with Ironman 4x4 Struts (except Pro), lift height subject to 1:2 motion ratio. Unnecessary fitment may lift vehicle too high

SWAY BAR

36mm Sway Bar			ISB600F	1
---------------	--	--	----------------	---

REAR SUSPENSION

SHOCK ABSORBER

Nitro Gas			12742GR	2
Foam Cell			24742FE	2
Foam Cell Pro			45742FE	2

- Non HBMC models only

COIL SPRINGS

Estimated Lift

Additional Load

Comfort	30mm	0 -300kg	NISS046A	1
Performance	40mm	0 -300kg	NISS046B	1
Constant Load	50mm	300kg - GVM	NISS046C	1

SWAY BAR

27mm Sway Bar			ISB600R	1
---------------	--	--	----------------	---

SUSPENSION KIT

Comfort w/ Gas Shocks	NISS045AKG
Comfort w/ Foam Cell	NISS045AKF
Comfort w/ Foam Cell Pro	NISS045AKP
Performance w/ Gas Shocks	NISS045BKG
Performance w/ Foam Cell	NISS045BKF
Performance w/ Foam Cell Pro	NISS045BKP
Constant Load w/ Gas Shocks	NISS045CKG
Constant Load w/ Foam Cell	NISS045CKF
Constant Load w/ Foam Cell Pro	NISS045CKP

- Non HBMC models only
- Mandatory 4 wheel alignment after installing new suspension

SUSPENSION KIT CONTENTS

Shock Absorbers	Coil Springs
Strut Shock Absorbers	



PATHFINDER / TERRANO / II

R20 / WD21

Pre 1995

NISSAN

Product

Part No.

Qty Req

FRONT SUSPENSION

SHOCK ABSORBER

Nitro Gas	12667GR	2
Foam Cell	24667FE	2

TORSION BAR

Up-rated Torsion Bars	NISS017	1
-----------------------	----------------	---

• Minimum 60mm downward suspension travel required

STEERING DAMPER

Foam Cell	3535	1
-----------	-------------	---

REAR SUSPENSION

SHOCK ABSORBER

Nitro Gas Comfort	12636GRC	2
Nitro Gas	12636GR	2
Foam Cell Comfort	24636FEC	2
Foam Cell	24636FE	2

COIL SPRINGS

Estimated Lift

Additional Load

	Estimated Lift	Additional Load		
Performance	40mm	0 -250kg	NISS018B	1
Constant Load	40mm	250kg - GVM	HOLD008B	1

SUSPENSION KIT

Performance w/ Gas Shocks	NISS018BKG
Performance w/ Foam Cell	NISS018BKF
Constant Load w/ Gas Shocks	NISS018CKG
Constant Load w/ Foam Cell	NISS018CKF

SUSPENSION KIT CONTENTS

Shock Absorbers	Torsion Bars
Coil Springs	

PATHFINDER

R50
1995+

Product	Part No.	Qty Req
---------	----------	---------

FRONT SUSPENSION

COIL SPRINGS	Estimated Lift	Additional Load		
Performance	35mm	0 - 50kg	NISS034B	1

CAMBER CORRECTION

Camber Bolt Kit			ICAMBER14	1
-----------------	--	--	------------------	---

REAR SUSPENSION

COIL SPRINGS	Estimated Lift	Additional Load		
Performance	35mm	0 - 200kg	NISS035B	1



PATHFINDER

R51 (4cyl Diesel and V6 Petrol)

7/2005+

NISSAN

Product

Part No.

Qty Req

FRONT SUSPENSION

SHOCK ABSORBER

Nitro Gas Strut			12716GR	2
Foam Cell Strut			24716FE	2

• Height adjustable with Ironman 4x4 Strut Trim Packers

COIL SPRINGS

	Estimated Lift	Additional Load		
Performance	35mm	0 - 50kg	NISS040B	1
Constant Load	35mm	50 - 110kg	NISS040C	1

TRIM PACKERS

5mm Strut Trim Packer	(Nitro Gas / Foam Cell)		HILFR05 / HILFR05F	2
10mm Strut Trim Packer	(Nitro Gas / Foam Cell)		HILFR10 / HILFR10F	2
15mm Strut Trim Packer	(Nitro Gas / Foam Cell)		HILFR15 / HILFR15F	2

• ONLY Compatible with Ironman 4x4 Struts, lift height subject to 1:2 motion ratio. Unnecessary fitment may lift vehicle too high

REAR SUSPENSION

SHOCK ABSORBER

Nitro Gas			12718GR	2
Foam Cell			24718FE	2

COIL SPRINGS

	Estimated Lift	Additional Load		
Performance	40mm	0 - 250kg	NISS042B	1
Constant Load	40mm	250kg - GVM	NISS042C	1

SUSPENSION KIT

Performance w/ Gas Shocks		NISS042BKG
Performance w/ Foam Cell		NISS042BKF
Constant Load w/ Gas Shocks		NISS042CKG
Constant Load w/ Foam Cell		NISS042CKF

• Specify front coil springs when ordering

• Mandatory 4 wheel alignment after installing new suspension

SUSPENSION KIT CONTENTS

Shock Absorbers	Coil Springs
Strut Shock Absorbers	

PATHFINDER

R51 (V6 Diesel)
7/2005+



Product	Part No.	Qty Req
---------	----------	---------

FRONT SUSPENSION

SHOCK ABSORBER

Nitro Gas Strut	12716GR	2
Foam Cell Strut	24716FE	2

• Height adjustable with Ironman 4x4 Strut Trim Packers

COIL SPRINGS

	Estimated Lift	Additional Load		
Performance	35mm	0 - 50kg	NISS040C	1
Constant Load	35mm	50 - 110kg	NISS040D	1

TRIM PACKERS

5mm Strut Trim Packer	(Nitro Gas / Foam Cell)	HILFR05 / HILFR05F	2
10mm Strut Trim Packer	(Nitro Gas / Foam Cell)	HILFR10 / HILFR10F	2
15mm Strut Trim Packer	(Nitro Gas / Foam Cell)	HILFR15 / HILFR15F	2

• ONLY Compatible with Ironman 4x4 Struts, lift height subject to 1:2 motion ratio. Unnecessary fitment may lift vehicle too high

REAR SUSPENSION

SHOCK ABSORBER

Nitro Gas	12718GR	2
Foam Cell	24718FE	2

COIL SPRINGS

	Estimated Lift	Additional Load		
Performance	40mm	0 - 250kg	NISS042B	1
Constant Load	40mm	250kg - GVM	NISS042C	1

SUSPENSION KIT

Performance w/ Gas Shocks	NISS042BKG1
Performance w/ Foam Cell	NISS042BKF1
Constant Load w/ Gas Shocks	NISS042CKG1
Constant Load w/ Foam Cell	NISS042CKF1

• Specify front coil springs when ordering

SUSPENSION KIT CONTENTS

Shock Absorbers	Coil Springs
Strut Shock Absorbers	



Product	Part No.	Qty Req
---------	----------	---------

FRONT SUSPENSION

SHOCK ABSORBER

Nitro Gas	12087GR	2
Foam Cell	24087FE	2

TORSION BAR

Upated Torsion Bars	NISS013	1
---------------------	----------------	---

• Minimum 60mm downward suspension travel required

REAR SUSPENSION

SHOCK ABSORBER

Nitro Gas Comfort	12636GRC	2
Nitro Gas	12636GR	2
Foam Cell Comfort	24636FEC	2
Foam Cell	24636FE	2

LEAF SPRINGS

	Estimated Lift	Additional Load		
Comfort Drivers Side	40mm	0 - 100kg	NISS014AD/S	1
Comfort Near Side	40mm	0 - 100kg	NISS014AN/S	1
Performance Drivers Side	40mm	0 - 250kg	NISS014BD/S	1
Performance Near Side	40mm	0 - 250kg	NISS014BN/S	1
Constant Load Drivers Side	40mm	250kg - GVM	NISS014CD/S	1
Constant Load Near Side	40mm	250kg - GVM	NISS014CN/S	1

U-BOLTS

U-Bolt Kit	788UBK	2
------------	---------------	---

POLYURETHANE SPRING BUSHES

Bush Kit	704UK	1
----------	--------------	---

GREASABLE SHACKLES AND PINS

Greasable Shackle	797	2
Greasable Pin	798	2

LOAD PLUS

Load Plus Helper Springs	LP3	1
--------------------------	------------	---

SUSPENSION KIT

Comfort w/ Gas Shocks	NISS014AKG
Comfort w/ Foam Cell	NISS014AKF
Performance w/ Gas Shocks	NISS014BKG
Performance w/ Foam Cell	NISS014BKF
Constant Load w/ Gas Shocks	NISS014CKG
Constant Load w/ Foam Cell	NISS014CKF

SUSPENSION KIT CONTENTS

Shock Absorbers	U-Bolts
Leaf Springs	Polyurethane Spring Bushes
Torsion Bars	

NAVARA

D22 / NP300 (Torsion Bar)
1997+



Product

Part No.

Qty Req

FRONT SUSPENSION

SHOCK ABSORBER

Nitro Gas **12791GR** 2

• Upper control arm may contact shock absorber, grind away material on control arm for clearance

TORSION BAR

Uprated Torsion Bars **NISS025** 1

• Minimum 60mm downward suspension travel required

REAR SUSPENSION

SHOCK ABSORBER

Nitro Gas Comfort **12636GRC** 2

Nitro Gas **12636GR** 2

LEAF SPRINGS

Estimated Lift

Additional Load

Comfort Drivers Side	40mm	0 - 100kg	NISS014AD/S	1
Comfort Near Side	40mm	0 - 100kg	NISS014AN/S	1
Performance Drivers Side	40mm	0 - 250kg	NISS014BD/S	1
Performance Near Side	40mm	0 - 250kg	NISS014BN/S	1
Constant Load Drivers Side	40mm	250kg - GVM	NISS014CD/S	1
Constant Load Near Side	40mm	250kg - GVM	NISS014CN/S	1

U-BOLTS

U-Bolt Kit **788UBK** 2

POLYURETHANE SPRING BUSHES

Bush Kit **704UK** 1

GREASABLE SHACKLES AND PINS

Greasable Shackle **797** 2

Greasable Pin **798** 2

LOAD PLUS

Load Plus Helper Springs **LP3** 1

SUSPENSION KIT

Comfort w/ Gas Shocks **NISS025AKG**

Performance w/ Gas Shocks **NISS025BKG**

Constant Load w/ Gas Shocks **NISS025CKG**

SUSPENSION KIT CONTENTS

Shock Absorbers	U-Bolts
Leaf Springs	Polyurethane Spring Bushes
Torsion Bars	



Product	Part No.	Qty Req
---------	----------	---------

FRONT SUSPENSION

SHOCK ABSORBER

Nitro Gas Strut	12716GR	2
Foam Cell Strut	24716FE	2
Foam Cell Pro Strut	45716FE	2

• Height adjustable with Ironman 4x4 Strut Trim Packers

COIL SPRINGS **Estimated Lift** **Additional Load**

Performance	35mm	0 - 50kg	NISS040B	1
Constant Load	35mm	50 - 110kg	NISS040C	1

TRIM PACKERS

5mm Strut Trim Packer	(Nitro Gas / Foam Cell)	HILFR05 / HILFR05F	2
10mm Strut Trim Packer	(Nitro Gas / Foam Cell)	HILFR10 / HILFR10F	2
15mm Strut Trim Packer	(Nitro Gas / Foam Cell)	HILFR15 / HILFR15F	2

• ONLY Compatible with Ironman 4x4 Struts (Except Pro), lift height subject to 1:2 motion ratio. Unnecessary fitment may lift vehicle too high

REAR SUSPENSION

SHOCK ABSORBER

Nitro Gas	12717GR	2
Foam Cell	24717FE	2
Foam Cell Pro	45717FE	2

LEAF SPRINGS **Estimated Lift** **Additional Load**

Performance	40mm	0 - 300kg	NISS041B	2
Constant Load	40mm	300 - 500kg	NISS041C	2
Extra Constant Load	40mm	500kg - GVM	NISS041D	2

U-BOLTS

U-Bolt Kit	Suits NISS041B and NISS041C Leaf Springs	437UBK	2
U-Bolt Kit Extra Long	Suits NISS041D Leaf Spring	678UBK	2

POLYURETHANE SPRING BUSHES

Bush Kit	769UK	1
----------	--------------	---

GREASABLE SHACKLES AND PINS

Greasable Shackle	797-1	2
-------------------	--------------	---

AXLE PROTECTION

ABS Wire and Axle Shield	IAP001	1
--------------------------	---------------	---

LOAD PLUS

Load Plus Helper Springs	LP2	1
--------------------------	------------	---

SUSPENSION KIT

Performance w/ Gas Shocks	NISS041BKG
Performance w/ Foam Cell	NISS041BKF
Performance w/ Foam Cell Pro	NISS041BKP
Constant Load w/ Gas Shocks	NISS041CKG
Constant Load w/ Foam Cell	NISS041CKF
Constant Load w/ Foam Cell Pro	NISS041CKP
Extra Constant Load w/ Gas Shocks	NISS041DKG
Extra Constant Load w/ Foam Cell	NISS041DKF
Extra Constant Load w/ Foam Cell Pro	NISS041DKP

• Specify front coil springs when ordering

SUSPENSION KIT CONTENTS

Shock Absorbers	U-Bolts
Coil Springs	Polyurethane Spring Bushes
Leaf Springs	

NAVARA

D40 (V6 Diesel)
2005+



Product **Part No.** **Qty Req**

FRONT SUSPENSION

SHOCK ABSORBER

Nitro Gas Strut			12716GR	2
Foam Cell Strut			24716FE	2
Foam Cell Pro Strut			45716FE	2

• Height adjustable with Ironman 4x4 Strut Trim Packers

COIL SPRINGS

	Estimated Lift	Additional Load		
Performance	35mm	0 - 50kg	NISS040C	1
Constant Load	35mm	50 - 110kg	NISS040D	1

TRIM PACKERS

5mm Strut Trim Packer	(Nitro Gas / Foam Cell)	HILFR05 / HILFR05F	2
10mm Strut Trim Packer	(Nitro Gas / Foam Cell)	HILFR10 / HILFR10F	2
15mm Strut Trim Packer	(Nitro Gas / Foam Cell)	HILFR15 / HILFR15F	2

• ONLY Compatible with Ironman 4x4 Struts (Except Pro), lift height subject to 1:2 motion ratio. Unnecessary fitment may lift vehicle too high

REAR SUSPENSION

SHOCK ABSORBER

Nitro Gas			12717GR	2
Foam Cell			24717FE	2
Foam Cell Pro			45717FE	2

LEAF SPRINGS

	Estimated Lift	Additional Load		
Performance	40mm	0 - 300kg	NISS041B	2
Constant Load	40mm	300 - 500kg	NISS041C	2
Extra Constant Load	40mm	500kg - GVM	NISS041D	2

U-BOLTS

U-Bolt Kit	Suits NISS041B and NISS041C Leaf Springs	437UBK	2
U-Bolt Kit Extra Long	Suits NISS041D Leaf Spring	678UBK	2

POLYURETHANE SPRING BUSHES

Bush Kit		769UK	1
----------	--	--------------	---

GREASABLE SHACKLES AND PINS

Greasable Shackle		797-1	2
-------------------	--	--------------	---

AXLE PROTECTION

ABS Wire and Axle Shield		IAP001	1
--------------------------	--	---------------	---

LOAD PLUS

Load Plus Helper Springs		LP2	1
--------------------------	--	------------	---

SUSPENSION KIT

Performance w/ Gas Shocks	NISS041BKG1
Performance w/ Foam Cell	NISS041BKF1
Performance w/ Foam Cell Pro	NISS041BKP1
Constant Load w/ Gas Shocks	NISS041CKG1
Constant Load w/ Foam Cell	NISS041CKF1
Constant Load w/ Foam Cell Pro	NISS041CKP1
Extra Constant Load w/ Gas Shocks	NISS041DKG1
Extra Constant Load w/ Foam Cell	NISS041DKF1
Extra Constant Load w/ Foam Cell Pro	NISS041DKP1

• Specify front coil springs when ordering

SUSPENSION KIT CONTENTS

Shock Absorbers	U-Bolts
Coil Springs	Polyurethane Spring Bushes
Leaf Springs	



Product	Part No.	Qty Req
---------	----------	---------

FRONT SUSPENSION

SHOCK ABSORBER

Nitro Gas Strut	12716GR	2
Foam Cell Strut	24716FE	2
Foam Cell Pro Strut	45716FE	2

• Height adjustable with Ironman 4x4 Strut Trim Packers

COIL SPRINGS **Estimated Lift** **Additional Load**

Performance	35mm	0 - 50kg	NISS040B	1
Constant Load	35mm	50 - 110kg	NISS040C	1

TRIM PACKERS

5mm Strut Trim Packer	(Nitro Gas / Foam Cell)	HILFR05 / HILFR05F	2
10mm Strut Trim Packer	(Nitro Gas / Foam Cell)	HILFR10 / HILFR10F	2
15mm Strut Trim Packer	(Nitro Gas / Foam Cell)	HILFR15 / HILFR15F	2

• ONLY Compatible with Ironman 4x4 Struts (Except Pro), lift height subject to 1:2 motion ratio. Unnecessary fitment may lift vehicle too high

REAR SUSPENSION

SHOCK ABSORBER

Nitro Gas Comfort	12698GRC	2
Nitro Gas	12698GR	2
Foam Cell Comfort	24698FEC	2
Foam Cell	24698FE	2
Foam Cell Pro Comfort	45698FEC	2
Foam Cell Pro	45698FE	2

LEAF SPRINGS **Estimated Lift** **Additional Load**

Performance	40mm	0 - 300kg	NISS057B	2
Constant Load	40mm	300kg - GVM	NISS057C	2

U-BOLTS

U-Bolt Kit	1104UBK	2
------------	----------------	---

POLYURETHANE SPRING BUSHES

Bush Kit	704TUK	1
----------	---------------	---

GREASABLE SHACKLES AND PINS

Greasable Shackle	797-3	2
-------------------	--------------	---

LOAD PLUS

Load Plus Helper Springs	LP2	1
--------------------------	------------	---

SUSPENSION KIT

Performance w/ Gas Shocks	NISS057BKG
Performance w/ Foam Cell	NISS057BKF
Performance w/ Foam Cell Pro	NISS057BKP
Constant Load w/ Gas Shocks	NISS057CKG
Constant Load w/ Foam Cell	NISS057CKF
Constant Load w/ Foam Cell Pro	NISS057CKP
Extra Constant Load w/ Gas Shocks	NISS057DKG
Extra Constant Load w/ Foam Cell	NISS057DKF
Extra Constant Load w/ Foam Cell Pro	NISS057DKP

• Specify front coil springs when ordering

SUSPENSION KIT CONTENTS

Shock Absorbers	U-Bolts
Coil Springs	Polyurethane Spring Bushes
Leaf Springs	

PALADIN

Pre 2005



Product	Part No.	Qty Req
---------	----------	---------

FRONT SUSPENSION

SHOCK ABSORBER

Nitro Gas	12791GR	2
-----------	---------	---

TORSION BAR

Upated Torsion Bars	NISS048	1
---------------------	---------	---

• Minimum 60mm downward suspension travel required

REAR SUSPENSION

SHOCK ABSORBER

Nitro Gas Comfort	12698GRC	2
-------------------	----------	---

Nitro Gas	12698GR	2
-----------	---------	---

LEAF SPRING

Estimated Lift

Additional Load

Performance	40mm	0 - 250kg	NISS049B	2
-------------	------	-----------	----------	---

U-BOLTS

U-Bolt Kit	654UBK	2
------------	--------	---

POLYURETHANE SPRING BUSHES

Bush Kit	769UKL	1
----------	--------	---

GREASABLE SHACKLES AND PINS

Greasable Shackle	797-2	2
-------------------	-------	---

Greasable Pin	798	2
---------------	-----	---

LOAD PLUS

Load Plus Helper Springs	LP2	1
--------------------------	-----	---

SUSPENSION KIT

Performance w/ Gas Shocks	NISS049BKG
---------------------------	------------

SUSPENSION KIT CONTENTS

Shock Absorbers	Polyurethane Spring Bushes
Leaf Springs	Shackles
U-Bolts	



Product	Part No.	Qty Req
---------	----------	---------

FRONT SUSPENSION

SHOCK ABSORBER

Nitro Gas Strut	12716GR	2
Foam Cell Strut	24716FE	2
Foam Cell Pro Strut	45716FE	2

• Height adjustable with Ironman 4x4 Strut Trim Packers

COIL SPRINGS **Estimated Lift** **Additional Load**

Performance	35mm	0 - 50kg	NISS040B	1
Constant Load	35mm	50 - 110kg	NISS040C	1

TRIM PACKERS

5mm Strut Trim Packer	(Nitro Gas / Foam Cell)	HILFR05 / HILFR05F	2
10mm Strut Trim Packer	(Nitro Gas / Foam Cell)	HILFR10 / HILFR10F	2
15mm Strut Trim Packer	(Nitro Gas / Foam Cell)	HILFR15 / HILFR15F	2

• ONLY Compatible with Ironman 4x4 Struts (Except Pro), lift height subject to 1:2 motion ratio. Unnecessary fitment may lift vehicle too high

REAR SUSPENSION

SHOCK ABSORBER

Nitro Gas	12717GR	2
Foam Cell	24717FE	2
Foam Cell Pro	45717FE	2

LEAF SPRINGS **Estimated Lift** **Additional Load**

Performance	45mm	0 - 300kg	NISS047B	2
-------------	------	-----------	-----------------	---

U-BOLTS

U-Bolt Kit	416UBK	2
------------	---------------	---

POLYURETHANE SPRING BUSHES

Bush Kit	769UK	1
----------	--------------	---

GREASABLE SHACKLES AND PINS

Greasable Shackle	797-1	2
-------------------	--------------	---

LOAD PLUS

Load Plus Helper Springs	LP2	1
--------------------------	------------	---

SUSPENSION KIT

Performance w/ Gas Shocks	NISS047BKG
Performance w/ Foam Cell	NISS047BKF
Performance w/ Foam Cell Pro	NISS047BKP

• Specify front coil springs when ordering

SUSPENSION KIT CONTENTS

Shock Absorbers	U-Bolts
Coil Springs	Polyurethane Spring Bushes
Leaf Springs	

XTRAILT30
2001 - 9/2007

Product	Part No.	Qty Req
---------	----------	---------

FRONT SUSPENSION

COIL SPRINGS	Estimated Lift	Additional Load		
Performance	35mm	0 - 50kg	NISS038B	1

CAMBER CORRECTION

Camber Bolt Kit			ICAMBER12	1
-----------------	--	--	------------------	---

REAR SUSPENSION

COIL SPRINGS	Estimated Lift	Additional Load		
Performance	35mm	0 -200kg	NISS039B	1



Product **Part No.** **Qty Req**

FRONT SUSPENSION

SHOCK ABSORBER

Nitro Gas Strut **12747GR** 2

COIL SPRINGS

Estimated Lift **Additional Load**

Performance 40mm 0 - 50kg **REN001B** 1

CAMBER CORRECTION

Camber Bolt Kit **ICAMBER12** 1

REAR SUSPENSION

SHOCK ABSORBER

Nitro Gas Strut **12748GR** 2

COIL SPRINGS

Estimated Lift **Additional Load**

Performance 40mm 0 - 200kg **REN002B** 1

CAMBER CORRECTION

Camber Bolt Kit **ICAMBER12** 1

SUSPENSION KIT

Performance w/ Gas Shocks **REN001BKG**

SUSPENSION KIT CONTENTS

Shock Absorbers
Coil Springs

Camber Correction

MUSSO AND KORANDO

1996+



Product	Part No.	Qty Req
---------	----------	---------

FRONT SUSPENSION**SHOCK ABSORBER**

Nitro Gas	12667GR	2
Foam Cell	24667FE	2

TORSION BAR

Uprated Torsion Bars	SSANG001	1
----------------------	-----------------	---

- Minimum 60mm downward suspension travel required

REAR SUSPENSION**SHOCK ABSORBER**

Nitro Gas	12661GRS	2
Foam Cell	24661FES	2

COIL SPRINGS**Estimated Lift****Additional Load**

Performance	45mm	0 -200kg	SSANG002B	1
-------------	------	----------	------------------	---

SUSPENSION KIT

Performance w/ Gas Shocks	SSANG002BKG
Performance w/ Foam Cell	SSANG002BKF

SUSPENSION KIT CONTENTS

Shock Absorbers	Torsion Bars
Coil Springs	



SIERRA

Samurai LJ, SJ (Leaf)
1981+

SUZUKI

Product

Part No.

Qty Req

FRONT SUSPENSION

SHOCK ABSORBER

Nitro Gas **12085GR** 2

LEAF SPRINGS

Estimated Lift

Additional Load

Drivers side 50mm 0 - 50kg **SUZ001BD/S** 1

Near Side 50mm 0 - 50kg **SUZ001BN/S** 1

STEERING DAMPER

Foam Cell **3530** 1

U-BOLTS

U-Bolt Kit Drivers side **654UBK** 1

U-Bolt Kit Near side **655UBK** 1

POLYURETHANE SPRING BUSHES

Bush Kit **734UK** 1

REAR SUSPENSION

SHOCK ABSORBER

Nitro Gas **12086GR** 2

LEAF SPRINGS

Estimated Lift

Additional Load

Performance 50mm 0 - 200kg **SUZ002B** 2

Performance Optional +20mm 50mm 0 - 200kg **SUZ002BD/S** 1

• *Optional D/S spring to offset uneven weight distribution, eg. Spare Wheel*

U-BOLTS

U-Bolt Kit **655UBK** 2

POLYURETHANE SPRING BUSHES

Bush Kit **734UK** 1

LOAD PLUS

Load Plus Helper Springs **LP5** 1

SUSPENSION KIT

Performance w/ Gas Shocks **SUZ001BKG**

SUSPENSION KIT CONTENTS

Shock Absorbers U-Bolts
Leaf Springs Polyurethane Spring Bushes

SIERRASJ80 (Coil)
1997+

Product	Part No.	Qty Req
---------	----------	---------

FRONT SUSPENSION

COIL SPRINGS	Estimated Lift	Additional Load		
Performance	35mm	0 -40kg	SUZ007B	1

OFFSET CASTER BUSH KIT

Offset Bush Kit			1146RK	1
-----------------	--	--	---------------	---

REAR SUSPENSION

COIL SPRINGS	Estimated Lift	Additional Load		
Performance	35mm	0 -200kg	SUZ008B	1

**JIMNY**

SN413

1998+

SUZUKI**Product** **Part No.** **Qty Req****FRONT SUSPENSION****SHOCK ABSORBER**Nitro Gas **12759GR** 2**STEERING DAMPER**Foam Cell Includes adaptor kit **3521S** 1**COIL SPRINGS****Estimated Lift****Additional Load**Performance 50mm 0 -200kg **SUZ009B** 1**OFFSET CASTER BUSH KIT**Offset Bush Kit **1146RK** 1**REAR SUSPENSION****SHOCK ABSORBER**Nitro Gas **12760GR** 2**COIL SPRINGS****Estimated Lift****Additional Load**Performance Japan Spec 50mm 0 -200kg **SUZ010B** 1Performance Euro Spec 50mm 0 -200kg **SUZ011B** 1*• SUZ010B are staggered height for Japan Spec vehicles, SUZ011B are equal height for Euro spec vehicles***SUSPENSION KIT**Performance w/ Gas Shocks **SUZ009BKG***• Specify rear coil springs when ordering***SUSPENSION KIT CONTENTS**

Shock Absorbers

Coil Springs



Product

Part No.

Qty Req

FRONT SUSPENSION**SHOCK ABSORBER**

Nitro Gas Strut	Full replacement strut	12083GR	2
-----------------	------------------------	----------------	---

COIL SPRINGS**Estimated Lift****Additional Load**

Performance SWB	35mm	0 - 50kg	SUZ003B	1
Performance LWB	35mm	0 - 50kg	SUZ005B	1

CAMBER CORRECTION

Camber Bolt Kit		ICAMBER12	1
-----------------	--	------------------	---

REAR SUSPENSION**SHOCK ABSORBER**

Nitro Gas	SWB	12089GR	2
Nitro Gas	LWB	12658GR	2

COIL SPRINGS**Estimated Lift****Additional Load**

Performance SWB	35mm	0 - 200kg	SUZ004B	1
Performance LWB	35mm	0 - 200kg	SUZ006B	1

SUSPENSION KIT

Performance w/ Gas Shocks	SWB	SUZ003BKG
Performance w/ Gas Shocks	LWB	SUZ005BKG

•SWB suits short wheel base vehicles

•LWB Suits long wheel base vehicles

SUSPENSION KIT CONTENTS

Shock Absorbers	Coil Springs
Strut Shock Absorbers	Camber Correction



Product

Part No.

Qty Req

FRONT SUSPENSION

SHOCK ABSORBER

Nitro Gas Strut	Full replacement strut	12083GR	2
-----------------	------------------------	----------------	---

COIL SPRINGS

Estimated Lift Additional Load

Performance 4 Cyl Carb	35mm	0 - 50kg	SUZ005B	1
Performance V6 / 4 Cyl Inj	35mm	0 - 50kg	SUZ015B	1
Performance XL7	35mm	0 - 50kg	SUZ017B	1

CAMBER CORRECTION

Camber Bolt Kit	ICAMBER12	1
-----------------	------------------	---

REAR SUSPENSION

SHOCK ABSORBER

Nitro Gas	SWB	12089GR	2
Nitro Gas	LWB	12658GR	2

COIL SPRINGS

Estimated Lift Additional Load

Performance SWB	35mm	0 - 200kg	SUZ013B	1
Performance LWB	35mm	0 - 200kg	SUZ016B	1
Performance XL7	35mm	0 - 200kg	SUZ018B	1

SUSPENSION KIT

Performance w/ Gas Shocks	SWB	SUZ013BKG
Performance w/ Gas Shocks	LWB	SUZ016BKG
Performance w/ Gas Shocks	XL7	SUZ018BKG

•SWB suits short wheel base vehicles

•LWB Suits long wheel base vehicles

SUSPENSION KIT CONTENTS

Shock Absorbers	Coil Springs
Strut Shock Absorbers	Camber Correction

GRAND VITARA

8/2005+



Product	Part No.	Qty Req
---------	----------	---------

FRONT SUSPENSION**SHOCK ABSORBER**

Nitro Gas Strut	McPherson Strut	12721GR	2
-----------------	-----------------	----------------	---

COIL SPRINGS**Estimated Lift****Additional Load**

Performance	40mm	0 - 50kg	SUZ019B	1
Constant Load	40mm	50 - 100kg	SUZ019C	1

CAMBER CORRECTION

Camber Bolt Kit		ICAMBER14	1
-----------------	--	------------------	---

REAR SUSPENSION**SHOCK ABSORBER**

Nitro Gas		12722GR	2
-----------	--	----------------	---

COIL SPRINGS**Estimated Lift****Additional Load**

Performance SWB (GV3)	40mm	0 - 200kg	SUZ020A	1
Performance LWB	40mm	0 - 200kg	SUZ020B	1

SUSPENSION KIT

Performance w/ Gas Shocks	SWB GV3	SUZ019AKG
Performance w/ Gas Shocks	LWB	SUZ019BKG

• SWB refers 3 door vehicles, LWB refers 5 door vehicles

• Monocoque constructed vehicles such as Suzuki Grand Vitara can be subject to increased NVH (Noise) with upgraded suspension installed

SUSPENSION KIT CONTENTS

Shock Absorbers	Coil Springs
Strut Shock Absorbers	Camber Correction

**FORESTER**SF5, GX, RX, GT
1997-2008**SUBARU****Product** **Part No.** **Qty Req****FRONT SUSPENSION**

COIL SPRINGS	Estimated Lift	Additional Load		
Performance 1997 - 2001	35mm	0 - 50kg	SUB001B	1
Performance 2002 - 2008	35mm	0 - 50kg	SUB003B	1
CAMBER CORRECTION				
Camber Bolt Kit			ICAMBER14	1

REAR SUSPENSION

COIL SPRINGS	Estimated Lift	Additional Load		
Performance 1997 - 2001	35mm	0 - 200kg	SUB002B	1
Performance 2002 - 2008	35mm	0 - 200kg	SUB004B	1
• Not suitable for self leveling suspension models				
CAMBER CORRECTION				
Camber Bolt Kit			ICAMBER14	1

HILUXSolid Front Axle
1979-10/1983

Product	Part No.	Qty Req
---------	----------	---------

FRONT SUSPENSION**SHOCK ABSORBER**

Nitro Gas Comfort	12639GRC	2
Nitro Gas	12639GR	2
Foam Cell	24639FE	2

LEAF SPRINGS**Estimated Lift****Additional Load**

	Estimated Lift	Additional Load		
Petrol Drivers Side	50mm	0 - 50kg	TOY010BD/S	1
Petrol Near Side	50mm	0 - 50kg	TOY010BN/S	1
Diesel or Constant Load D/S	50mm	0 - 100kg	TOY010CD/S	1
Diesel or Constant Load N/S	50mm	0 - 100kg	TOY010CN/S	1

• Check clearance to drag link / ubolt, an adjustable drag link may be required

STEERING DAMPER

Foam Cell	3521	1
-----------	------	---

U-BOLTS

Drivers Side U-Bolt Kit	678UBK	1
Near Side U-Bolt Kit	437UBK	1

POLYURETHANE SPRING BUSHES

Bush Kit	732UK	1
----------	-------	---

GREASABLE SHACKLES AND PINS

Greasable Shackle	384	2
Greasable Pin	385	2

REAR SUSPENSION**SHOCK ABSORBER**

Nitro Gas Comfort	12636GRC	2
Nitro Gas	12636GR	2
Foam Cell Comfort	24636FEC	2
Foam Cell	24636FE	2

LEAF SPRINGS**Estimated Lift****Additional Load**

	Estimated Lift	Additional Load		
Performance	50mm	0 - 300kg	TOY011B	2
Constant Load	50mm	300kg - GVM	TOY011C	2

U-BOLTS

U-Bolt Kit	437UBK	2
------------	--------	---

POLYURETHANE SPRING BUSHES

Bush Kit	733UK	1
----------	-------	---

GREASABLE SHACKLES AND PINS

Greasable Shackle		386	2
Greasable Shackle	Extended 5mm	386-2	2
Greasable Pin		385	2

LOAD PLUS

Load Plus Helper Springs	LP2	1
--------------------------	-----	---

SUSPENSION KIT

Performance w/ Gas Shocks	TOY010BKG1
Performance w/ Foam Cell	TOY010BKF1
Constant Load w/ Gas Shocks	TOY010CKG1
Constant Load w/ Foam Cell	TOY010CKF1

• Specify front leaf springs when ordering

SUSPENSION KIT CONTENTS

Shock Absorbers	U-Bolts
Leaf Springs	Polyurethane Spring Bushes



HILUX

Solid Front Axle
11/1983-11/1997

TOYOTA

Product Part No. Qty Req

FRONT SUSPENSION

SHOCK ABSORBER

Nitro Gas Comfort	12639GRC	2
Nitro Gas	12639GR	2
Foam Cell	24639FE	2

LEAF SPRINGS Estimated Lift Additional Load

Petrol Drivers Side	50mm	0 - 50kg	TOY010BD/S	1
Petrol Near Side	50mm	0 - 50kg	TOY010BN/S	1
Diesel or Constant Load D/S	50mm	0 - 100kg	TOY010CD/S	1
Diesel or Constant Load N/S	50mm	0 - 100kg	TOY010CN/S	1

• Check clearance to drag link / ubolt, an adjustable drag link may be required

STEERING DAMPER

Foam Cell	3521	1
-----------	-------------	---

U-BOLTS

Drivers Side U-Bolt Kit	678UBK	1
Near Side U-Bolt Kit	437UBK	1

POLYURETHANE SPRING BUSHES

Bush Kit	732UK	1
----------	--------------	---

GREASABLE SHACKLES AND PINS

Greasable Shackle	384	2
Greasable Pin	385	2

REAR SUSPENSION

SHOCK ABSORBER

Nitro Gas Comfort	12650GRC	2
Nitro Gas	12650GR	2
Foam Cell Comfort	24650FEC	2
Foam Cell	24650FE	2

LEAF SPRINGS Estimated Lift Additional Load

Performance	50mm	0 -300kg	TOY011B	2
Constant Load	50mm	300kg - GVM	TOY011C	2

U-BOLTS

U-Bolt Kit	437UBK	2
------------	---------------	---

POLYURETHANE SPRING BUSHES

Bush Kit	733UK	1
----------	--------------	---

GREASABLE SHACKLES AND PINS

Greasable Shackle		386	2
Greasable Shackle	Extended 5mm	386-2	2
Greasable Pin		385	2

LOAD PLUS

Load Plus Helper Springs	LP2	1
--------------------------	------------	---

SUSPENSION KIT

Performance w/ Gas Shocks	TOY010BKG2
Performance w/ Foam Cell	TOY010BKF2
Constant Load w/ Gas Shocks	TOY010CKG2
Constant Load w/ Foam Cell	TOY010CKF2

• Specify front leaf springs when ordering

SUSPENSION KIT CONTENTS

Shock Absorbers	U-Bolts
Leaf Springs	Polyurethane Spring Bushes

HILUXTiger 107, 108, 110, 111, 167
1997-2005**Product****Part No.****Qty Req****FRONT SUSPENSION****SHOCK ABSORBER**

Nitro Gas	12088GR	2
Foam Cell	24088FE	2

TORSION BAR

Uprated Torsion Bars	TOY026	1
----------------------	---------------	---

- Minimum 60mm downward suspension travel required

STEERING DAMPER

Foam Cell	3533	1
-----------	-------------	---

- Check clearance to engine sump when fitting steering damper

REAR SUSPENSION**SHOCK ABSORBER**

Nitro Gas Comfort	12081GRC	2
Nitro Gas	12081GR	2
Foam Cell Comfort	24081FEC	2
Foam Cell	24081FE	2

LEAF SPRINGS**Estimated Lift****Additional Load**

Comfort	40mm	0 -100kg	TOY027A	2
Performance	40mm	0 -200kg	TOY027B	2
Constant Load	40mm	200kg - GVM	TOY027C	2

- 1300mm Leaf Length

U-BOLTS

U-Bolt Kit		437UBK	2
U-Bolt Kit Extra long	Suits TOY027A Spring	678UBK	2

POLYURETHANE SPRING BUSHES

Bush Kit	758UK	1
----------	--------------	---

GREASABLE SHACKLES AND PINS

Greasable Shackle	Stepped Shackle	386-1	2
Non-Greasable Pin		387-1	2

LOAD PLUS

Load Plus Helper Springs	LP2	1
--------------------------	------------	---

SUSPENSION KIT

Comfort w/ Gas Shocks	TOY027AKG
Comfort w/ Foam Cell	TOY027AKF
Performance w/ Gas Shocks	TOY027BKG
Performance w/ Foam Cell	TOY027BKF
Constant Load w/ Gas Shocks	TOY027CKG
Constant Load w/ Foam Cell	TOY027CKF

SUSPENSION KIT CONTENTS

Shock Absorbers	U-Bolts
Leaf Springs	Polyurethane Spring Bushes
Torsion Bars	



4RUNNER

Gen 1, N60 (Leaf)

1988-1997

TOYOTA

Product

Part No.

Qty Req

FRONT SUSPENSION

SHOCK ABSORBER

Nitro Gas	12088GR	2
Foam Cell	24088FE	2

TORSION BAR

Up-rated Torsion Bars	TOY026	1
-----------------------	---------------	---

• Minimum 60mm downward suspension travel required

STEERING DAMPER

Foam Cell	3533	1
-----------	-------------	---

REAR SUSPENSION

SHOCK ABSORBER

Nitro Gas Comfort	12650GRC	2
Nitro Gas	12650GR	2
Foam Cell Comfort	24650FEC	2
Foam Cell	24650FE	2

LEAF SPRINGS

Estimated Lift

Additional Load

Performance	50mm	0 -300kg	TOY011B	2
Constant Load	50mm	300kg - GVM	TOY011C	2

• 1200mm Leaf Length

U-BOLTS

U-Bolt Kit	437UBK	2
------------	---------------	---

POLYURETHANE SPRING BUSHES

Bush Kit	733UK	1
----------	--------------	---

GREASABLE SHACKLES AND PINS

Greasable Shackle	Straight Shackle	386	2
Greasable Shackle	Straight Shackle Extended 5mm	386-2	2
Greasable Pin		385	2

LOAD PLUS

Load Plus Helper Springs	LP2	1
--------------------------	------------	---

SUSPENSION KIT

Performance w/ Gas Shocks	TOY011BKG
Performance w/ Foam Cell	TOY011BKF
Constant Load w/ Gas Shocks	TOY011CKG
Constant Load w/ Foam Cell	TOY011CKF

SUSPENSION KIT CONTENTS

Shock Absorbers	U-Bolts
Leaf Springs	Polyurethane Spring Bushes
Torsion Bars	

4RUNNER / SURFGen 2, N130 V6 (Coil)
1990-1997

Product	Part No.	Qty Req
---------	----------	---------

FRONT SUSPENSION**SHOCK ABSORBER**

Nitro Gas	12088GR	2
Foam Cell	24088FE	2

TORSION BAR

Uprated Torsion Bars	TOY026	1
----------------------	---------------	---

- Minimum 60mm downward suspension travel required.

STEERING DAMPER

Foam Cell	3533	1
-----------	-------------	---

REAR SUSPENSION**SHOCK ABSORBER**

Nitro Gas Comfort	12637GRC	2
Nitro Gas	12637GR	2
Foam Cell Comfort	24637FEC	2
Foam Cell	24637FE	2

COIL SPRINGS**Estimated Lift****Additional Load**

	Estimated Lift	Additional Load	Part No.	Qty Req
Performance	45mm	0 -200kg	TOY023B	1
Constant Load	45mm	200kg - GVM	TOY023C	1

SUSPENSION KIT

Performance w/ Gas Shocks	TOY023BKG
Performance w/ Foam Cell	TOY023BKF
Constant Load w/ Gas Shocks	TOY023CKG
Constant Load w/ Foam Cell	TOY023CKF

SUSPENSION KIT CONTENTS

Shock Absorbers	Torsion Bars
Coil Springs	



4RUNNER

Gen 3, N180-N185

1996-2002

TOYOTA

Product

Part No.

Qty Req

FRONT SUSPENSION

SHOCK ABSORBER

Nitro Gas Strut			12691GR	2
Foam Cell Strut			24691FE	2
Foam Cell Pro Strut			45691FE	2

• Height adjustable with Ironman 4x4 Strut Trim Packers.

COIL SPRINGS

Estimated Lift

Additional Load

Performance	45mm	0 - 50kg	TOY038B	1
Constant Load	45mm	50 - 110kg	TOY038C	1

TRIM PACKERS

5mm Strut Trim Packer	(Nitro Gas / Foam Cell)		HILFR05 / HILFR05F	2
10mm Strut Trim Packer	(Nitro Gas / Foam Cell)		HILFR10 / HILFR10F	2
15mm Strut Trim Packer	(Nitro Gas / Foam Cell)		HILFR15 / HILFR15F	2

• ONLY Compatible with Ironman 4x4 Struts (except Pro), lift height subject to 1:2 motion ratio. Unnecessary fitment may lift vehicle too high.

REAR SUSPENSION

SHOCK ABSORBER

Nitro Gas			12661GR	2
Foam Cell			24661FE	2
Foam Cell Pro			45661FE	2

COIL SPRINGS

Estimated Lift

Additional Load

Comfort	30mm	0 - 200kg	TOY039A	1
Performance	45mm	0 - 300kg	TOY039B	1
Constant Load	45mm	300kg - GVM	TOY039C	1

COIL SPACER

Polyurethane 20mm			LCF20	2
Polyurethane 30mm			LCF30	2

SUSPENSION KIT

Comfort w/ Gas Shocks	TOY038AKG
Comfort w/ Foam Cell	TOY038AKF
Comfort w/ Foam Cell Pro	TOY038AKP
Performance w/ Gas Shocks	TOY038BKG
Performance w/ Foam Cell	TOY038BKF
Performance w/ Foam Cell Pro	TOY038BKP
Constant Load w/ Gas Shocks	TOY038BKG1
Constant Load w/ Foam Cell	TOY038BKF1
Constant Load w/ Foam Cell Pro	TOY038BKP1

SUSPENSION KIT CONTENTS

Shock Absorbers	Coil Springs
Strut Shock Absorbers	

4RUNNERGen 4 and 5, N210-N280
2003+

Product	Part No.	Qty Req
---------	----------	---------

FRONT SUSPENSION**SHOCK ABSORBER**

Nitro Gas Strut	12710GR	2
Foam Cell Strut	24710FE	2
Foam Cell Pro Strut	45710FE	2

• Height adjustable with Ironman 4x4 Strut Trim Packers.

COIL SPRINGS

	Estimated Lift	Additional Load		
Comfort	30mm	0 - 50kg	TOY055A	1
Performance	45mm	0 - 50kg	TOY055B	1
Constant Load	45mm	50 - 110kg	TOY055C	1

TRIM PACKERS

5mm Strut Trim Packer	(Nitro Gas / Foam Cell)	HILFR05 / HILFR05F	2
10mm Strut Trim Packer	(Nitro Gas / Foam Cell)	HILFR10 / HILFR10F	2
15mm Strut Trim Packer	(Nitro Gas / Foam Cell)	HILFR15 / HILFR15F	2

• ONLY Compatible with Ironman 4x4 Struts (except Pro), lift height subject to 1:2 motion ratio. Unnecessary fitment may lift vehicle too high.

SPACER KIT

Sway Bar Spacer	1198K	1
-----------------	--------------	---

REAR SUSPENSION**SHOCK ABSORBER**

Nitro Gas	12682GRC	2
Foam Cell	24682FEC	2
Foam Cell Pro	45682FEC	2

COIL SPRINGS

	Estimated Lift	Additional Load		
Comfort	30mm	0 - 300kg	TOY056A	1
Performance	45mm	0 - 300kg	TOY056B	1
Constant Load	45mm	300kg - GVM	TOY056C	1

COIL SPACER

Polyurethane 20mm	LCPR20	2
Polyurethane 25mm	LCPR25	2

SWAY BAR LINK

Extended Sway Bar Link	SBEXT006	2
------------------------	-----------------	---

SUSPENSION KIT

Comfort w/ Gas Shocks	TOY055AKG
Comfort w/ Foam Cell	TOY055AKF
Comfort w/ Foam Cell Pro	TOY055AKP
Performance w/ Gas Shocks	TOY055BKG
Performance w/ Foam Cell	TOY055BKF
Performance w/ Foam Cell Pro	TOY055BKP
Constant Load w/ Gas Shocks	TOY055CKG
Constant Load w/ Foam Cell	TOY055CKF
Constant Load w/ Foam Cell Pro	TOY055CKP

SUSPENSION KIT CONTENTS

Shock Absorbers	Coil Springs
Strut Shock Absorbers	



Product

Part No.

Qty Req

FRONT SUSPENSION

SHOCK ABSORBER

Nitro Gas Strut	Left Hand Side	12764GR LH	1
Nitro Gas Strut	Right Hand Side	12764GR RH	1

• Height adjustable with Ironman 4x4 Strut Trim Packers.

COIL SPRINGS

Estimated Lift

Additional Load

Performance	40mm	0 -50kg	TOY067B	1
-------------	------	---------	----------------	---

TRIM PACKERS

5mm Nitro Gas Strut Trim Packer	HILFR05	2
10mm Nitro Gas Strut Trim Packer	HILFR10	2
15mm Nitro Gas Strut Trim Packer	HILFR15	2

• ONLY Compatible with Ironman 4x4 Struts, lift height subject to 1:2 motion ratio. Unnecessary fitment may lift vehicle too high

REAR SUSPENSION

SHOCK ABSORBER

Nitro Gas Comfort	12650GRC	2
Nitro Gas	12650GR	2
Foam Cell Comfort	24650FEC	2
Foam Cell	24650FE	2

LEAF SPRINGS

Estimated Lift

Additional Load

Performance	45mm	0 -200kg	TOY068B	2
-------------	------	----------	----------------	---

U-BOLTS

U-Bolt Kit	415UBK	2
------------	---------------	---

POLYURETHANE SPRING BUSHES

Bush Kit	(18mm Front Pin)	767UK	1
Bush Kit	(23mm Front Pin)	1151UK	1

GREASABLE SHACKLES AND PINS

Greasable Shackle	386-3	2
Non-Greasable Pin	387-1	2

• 18mm Pin

LOAD PLUS

Load Plus Helper Springs	LP2	1
--------------------------	------------	---

SUSPENSION KIT

Performance w/ Gas Shocks	TOY068BKG
---------------------------	------------------

• Specify leaf spring front bush I/D before ordering

SUSPENSION KIT CONTENTS

Shock Absorbers	Leaf Springs
Strut Shock Absorbers	U-Bolts
Coil Springs	Polyurethane Spring Bushes



Product	Part No.	Qty Req
---------	----------	---------

FRONT SUSPENSION**SHOCK ABSORBER**

Nitro Gas Strut	12710GR	2
Foam Cell Strut	24710FE	2
Foam Cell Pro Strut	45710FE	2

• Height adjustable with Ironman 4x4 Strut Trim Packers

COIL SPRINGS	Estimated Lift	Additional Load		
--------------	----------------	-----------------	--	--

Comfort	40mm	0 - 50kg	TOY055A	1
Performance	45mm	0 - 50kg	TOY055B	1
Constant Load	45mm	50 - 110kg	TOY055C	1

TRIM PACKERS

5mm Strut Trim Packer	(Nitro Gas / Foam Cell)	HILFR05 / HILFR05F	2
10mm Strut Trim Packer	(Nitro Gas / Foam Cell)	HILFR10 / HILFR10F	2
15mm Strut Trim Packer	(Nitro Gas / Foam Cell)	HILFR15 / HILFR15F	2

• ONLY Compatible with Ironman 4x4 Struts (except Pro), lift height subject to 1:2 motion ratio. Unnecessary fitment may lift vehicle too high

SPACER KIT

Sway Bar Spacer	1198K	1
-----------------	-------	---

REAR SUSPENSION**SHOCK ABSORBER**

Nitro Gas Comfort	12650GRC	2
Nitro Gas	12650GR	2
Foam Cell Comfort	24650FEC	2
Foam Cell	24650FE	2
Foam Cell Pro Comfort	45650FEC	2
Foam Cell Pro	45650FE	2
Nitro Gas Extra Long Comfort	12081GRC	2
Nitro Gas Extra Long	12081GR	2
Foam Cell Extra Long Comfort	24081FEC	2
Foam Cell Extra Long	24081FE	2
Foam Cell Pro Extra Long Comfort	45081FEC	2
Foam Cell Pro Extra Long	45081FE	2

LEAF SPRINGS	Estimated Lift	Additional Load		
--------------	----------------	-----------------	--	--

Comfort	45mm	0 - 100kg	TOY057A	2
Performance	45mm	0 - 200kg	TOY057B	2
Constant Load	45mm	200 - 400kg	TOY057C	2
Extra Constant Load	45mm	400kg - GVM	TOY057D	2

U-BOLTS

U-Bolt Kit		437UBK	2
U-Bolt Kit Extra long	Suits TOY027A Spring	678UBK	2

POLYURETHANE SPRING BUSHES

Bush Kit	767UK	1
----------	-------	---

GREASABLE SHACKLES AND PINS

Greasable Shackle	386-3	2
Non-Greasable Pin	387-1	2

LOAD PLUS

Load Plus Helper Springs	LP2	1
--------------------------	-----	---

CONTINUED NEXT PAGE



Listing Continued

Product	Part No.	Qty Req
---------	----------	---------

SUSPENSION KIT

Comfort w/ Gas Shocks	TOY057AKG	
Comfort w/ Foam Cell	TOY057AKF	
Comfort w/ Foam Cell Pro	TOY057AKP	
Performance w/ Gas Shocks	TOY057BKG	
Performance w/ Foam Cell	TOY057BKF	
Performance w/ Foam Cell Pro	TOY057BKP	
Constant Load w/ Gas Shocks	TOY057CKG	
Constant Load w/ Foam Cell	TOY057CKF	
Constant Load w/ Foam Cell Pro	TOY057CKP	
Extra Constant Load w/ Gas Shocks	TOY057DKG	
Extra Constant Load w/ Foam Cell	TOY057DKF	
Extra Constant Load w/ Foam Cell Pro	TOY057DKP	

• Specify Front Coil Springs when ordering

GVM UPGRADE

Pre Registration	Temporary Load	TOY057CKFGVM
Post Registration	Temporary Load	TOY057CKFGVM1
Pre Registration	Permanent Load	TOY057DKFGVM
Post Registration	Permanent Load	TOY057DKFGVM1

• Australian Customers Only

• Only available through authorised Ironman 4x4 GVM upgrade installers



SUSPENSION KIT CONTENTS

Shock Absorbers	Leaf Springs
Strut Shock Absorbers	U-Bolts
Coil Springs	Polyurethane Spring Bushes

GVM UPGRADE KIT CONTENTS

Shock Absorbers	Polyurethane Spring Bushes
Strut Shock Absorbers	Greasable Shackles
Coil Springs	Compliance Plate
Leaf Springs	Tyre Placard
U-Bolts	

LANDCRUISER

40 Series
1960-1980

Product	Part No.	Qty Req
---------	----------	---------

FRONT SUSPENSION**SHOCK ABSORBER**

Nitro Gas Comfort	12635GRC	2
Nitro Gas	12635GR	2
Foam Cell Comfort	24635FEC	2
Foam Cell	24635FE	2
Foam Cell Pro	45635FE	2

LEAF SPRINGS	Estimated Lift	Additional Load		
Performance	50mm	0 - 100kg	TOY001B	2

STEERING DAMPER

Foam Cell	3523	1
-----------	------	---

U-BOLTS

U-Bolt Kit	415UBK	2
------------	--------	---

POLYURETHANE SPRING BUSHES

Bush Kit	713UK	1
----------	-------	---

GREASABLE SHACKLES AND PINS

Greasable Shackle	Left Hand Side	343LH	1
Greasable Shackle	Right Hand Side	343RH	1
Greasable Pin		346	2

REAR SUSPENSION**SHOCK ABSORBER**

Nitro Gas Comfort	12636GRC	2
Nitro Gas	12636GR	2
Foam Cell Comfort	24636FEC	2
Foam Cell	24636FE	2
Foam Cell Pro Comfort	45636FEC	2
Foam Cell Pro	45636FE	2

LEAF SPRINGS	Estimated Lift	Additional Load		
Performance	50mm	0 - 200kg	TOY002B	2

U-BOLTS

U-Bolt Kit	415UBK	2
------------	--------	---

POLYURETHANE SPRING BUSHES

Bush Kit	714UK	1
----------	-------	---

GREASABLE SHACKLES AND PINS

Greasable Shackle	Left Hand Side	343RH	1
Greasable Shackle	Right Hand Side	343LH	1
Greasable Pin		346	2

LOAD PLUS

Load Plus Helper Springs	LP4	1
--------------------------	-----	---

SUSPENSION KIT

Performance w/ Gas Shocks	TOY001BKG
Performance w/ Foam Cell	TOY001BKF
Performance w/ Foam Cell Pro	TOY001BKP

SUSPENSION KIT CONTENTS

Shock Absorbers	U-Bolts
Leaf Springs	Polyurethane Spring Bushes



Product **Part No.** **Qty Req**

FRONT SUSPENSION

SHOCK ABSORBER

Nitro Gas Comfort			12635GRC	2
Nitro Gas			12635GR	2
Foam Cell Comfort			24635FEC	2
Foam Cell			24635FE	2
Foam Cell Pro			45635FE	2

LEAF SPRINGS

	Estimated Lift	Additional Load		
Performance	50mm	0 - 80kg	TOY004B	2
Constant Load	50mm	80 - 120kg	TOY004C	2

STEERING DAMPER

Foam Cell			3523	1
-----------	--	--	-------------	---

U-BOLTS

U-Bolt Kit			415UBK	2
------------	--	--	---------------	---

POLYURETHANE SPRING BUSHES

Bush Kit			719UK	1
----------	--	--	--------------	---

GREASABLE SHACKLES AND PINS

Greasable Shackle	Left Hand Side		348LH	1
Greasable Shackle	Right Hand Side		348RH	1
Greasable Pin			351	2

REAR SUSPENSION

SHOCK ABSORBER

Nitro Gas Comfort			12636GRC	2
Nitro Gas			12636GR	2
Foam Cell Comfort			24636FEC	2
Foam Cell			24636FE	2
Foam Cell Pro Comfort			45636FEC	2
Foam Cell Pro			45636FE	2

LEAF SPRINGS

	Estimated Lift	Additional Load		
Constant Load	50mm	0 - 200kg	TOY034B	2

U-BOLTS

U-Bolt Kit			415UBK	2
------------	--	--	---------------	---

POLYURETHANE SPRING BUSHES

Bush Kit			719UK	1
----------	--	--	--------------	---

GREASABLE SHACKLES AND PINS

Greasable Shackle	Left Hand Side		348RH	1
Greasable Shackle	Right Hand Side		348LH	1
Greasable Pin			351	2

LOAD PLUS

Load Plus Helper Springs			LP4	1
--------------------------	--	--	------------	---

SUSPENSION KIT

Performance w/ Gas Shocks	TOY004BKG
Performance w/ Foam Cell	TOY004BKF
Performance w/ Foam Cell Pro	TOY004BKP

SUSPENSION KIT CONTENTS

Shock Absorbers	U-Bolts
Leaf Springs	Polyurethane Spring Bushes

LANDCRUISER

45 Series
1960-1980

Product	Part No.	Qty Req
---------	----------	---------

FRONT SUSPENSION**SHOCK ABSORBER**

Nitro Gas Comfort	12635GRC	2
Nitro Gas	12635GR	2
Foam Cell Comfort	24635FEC	2
Foam Cell	24635FE	2
Foam Cell Pro	45635FE	2

LEAF SPRINGS	Estimated Lift	Additional Load	Part No.	Qty Req
Performance	50mm	0 - 100kg	TOY001B	2

STEERING DAMPER

Foam Cell	3523	1
-----------	-------------	---

U-BOLTS

U-Bolt Kit	415UBK	2
------------	---------------	---

POLYURETHANE SPRING BUSHES

Bush Kit	713UK	1
----------	--------------	---

GREASABLE SHACKLES AND PINS

Greasable Shackle	Left Hand Side	343LH	1
Greasable Shackle	Right Hand Side	343RH	1
Greasable Pin		346	2

REAR SUSPENSION**SHOCK ABSORBER**

Nitro Gas Comfort	12636GRC	2
Nitro Gas	12636GR	2
Foam Cell Comfort	24636FEC	2
Foam Cell	24636FE	2
Foam Cell Pro Comfort	45636FEC	2
Foam Cell Pro	45636FE	2

LEAF SPRINGS	Estimated Lift	Additional Load	Part No.	Qty Req
Constant Load	50mm	0 - 400kg	TOY003C	2

U-BOLTS

U-Bolt Kit	415UBK	2
------------	---------------	---

POLYURETHANE SPRING BUSHES

Bush Kit	714UK	1
----------	--------------	---

GREASABLE SHACKLES AND PINS

Greasable Shackle	Left Hand Side	344	1
Greasable Shackle	Right Hand Side	345	1
Greasable Pin		347	2

LOAD PLUS

Load Plus Helper Springs	LP4	1
--------------------------	------------	---

SUSPENSION KIT

Constant Load w/ Gas Shocks	TOY003BKG
Constant Load w/ Foam Cell	TOY003BKF
Constant Load w/ Foam Cell	TOY003BKP

SUSPENSION KIT CONTENTS

Shock Absorbers	U-Bolts
Leaf Springs	Polyurethane Spring Bushes



Product

Part No.

Qty Req

FRONT SUSPENSION

SHOCK ABSORBER

Nitro Gas Comfort			12635GRC	2
Nitro Gas			12635GR	2
Foam Cell Comfort			24635FEC	2
Foam Cell			24635FE	2
Foam Cell Pro			45635FE	2

LEAF SPRINGS

Estimated Lift

Additional Load

Performance	50mm	0 - 80kg	TOY004B	2
Constant Load	50mm	80 - 120kg	TOY004C	2

STEERING DAMPER

Foam Cell			3523	1
-----------	--	--	-------------	---

U-BOLTS

U-Bolt Kit	Drivers Side		449UBK	1
U-Bolt Kit	Near Side		415UBK	1

POLYURETHANE SPRING BUSHES

Bush Kit			719UK	1
----------	--	--	--------------	---

GREASABLE SHACKLES AND PINS

Greasable Shackle	Left Hand Side		348LH	1
Greasable Shackle	Right Hand Side		348RH	1
Greasable Pin			351	2

REAR SUSPENSION

SHOCK ABSORBER

Nitro Gas Comfort			12636GRC	2
Nitro Gas			12636GR	2
Foam Cell Comfort			24636FEC	2
Foam Cell			24636FE	2
Foam Cell Pro Comfort			45636FEC	2
Foam Cell Pro			45636FE	2

LEAF SPRINGS

Estimated Lift

Additional Load

Performance	50mm	0 - 400kg	TOY005C	2
-------------	------	-----------	----------------	---

U-BOLTS

U-Bolt Kit			415UBK	2
------------	--	--	---------------	---

POLYURETHANE SPRING BUSHES

Bush Kit			719UK	1
----------	--	--	--------------	---

GREASABLE SHACKLES AND PINS

Greasable Shackle	Left Hand Side		353LH	1
Greasable Shackle	Right Hand Side		353RH	1
Greasable Pin			351	2

LOAD PLUS

Load Plus Helper Springs			LP4	1
--------------------------	--	--	------------	---

SUSPENSION KIT

Constant Load w/ Gas Shocks	TOY005BKG
Constant Load w/ Foam Cell	TOY005BKF
Constant Load w/ Foam Cell	TOY005BKP

SUSPENSION KIT CONTENTS

Shock Absorbers	U-Bolts
Leaf Springs	Polyurethane Spring Bushes

LANDCRUISER

60 Series
Pre 1986

Product	Part No.	Qty Req
---------	----------	---------

FRONT SUSPENSION**SHOCK ABSORBER**

Nitro Gas Comfort			12637GRC	2
Nitro Gas			12637GR	2
Foam Cell Comfort			24637FEC	2
Foam Cell			24637FE	2
Foam Cell Pro Comfort			45637FEC	2
Foam Cell Pro			45637FE	2

LEAF SPRINGS	Estimated Lift	Additional Load		
Petrol	50mm	0 - 80kg	TOY006B	2
Diesel or Bullbar	50mm	50 - 100kg	TOY006C	2
Turbo Diesel	50mm	50 - 100kg	TOY006D	2

STEERING DAMPER

Foam Cell			3524	1
-----------	--	--	-------------	---

U-BOLTS

U-Bolt Kit			436UBK	2
------------	--	--	---------------	---

POLYURETHANE SPRING BUSHES

Bush Kit			719UK	1
----------	--	--	--------------	---

GREASABLE SHACKLES AND PINS

Greasable Shackle	Left Hand Side		348LH	1
Greasable Shackle	Right Hand Side		348RH	1
Greasable Pin			351	2

REAR SUSPENSION**SHOCK ABSORBER**

Nitro Gas Comfort			12636GRC	2
Nitro Gas			12636GR	2
Foam Cell Comfort			24636FEC	2
Foam Cell			24636FE	2
Foam Cell Pro Comfort			45636FEC	2
Foam Cell Pro			45636FE	2

LEAF SPRINGS	Estimated Lift	Additional Load		
Comfort Drivers side	50mm	0 - 200kg	TOY007AD/S	1
Comfort Near side	50mm	0 - 200kg	TOY007AN/S	1
Performance Drivers side	50mm	0 - 200kg	TOY007BD/S	1
Performance Near side	50mm	0 - 200kg	TOY007BN/S	1
Constant Load Drivers side	50mm	200kg - GVM	TOY007CD/S	1
Constant Load Near side	50mm	200kg - GVM	TOY007CN/S	1

• Side hinge barn door models may require (D/S-D/S) or (N/S-N/S) rear spring configuration to maintain level

U-BOLTS

U-Bolt Kit			415UBK	2
------------	--	--	---------------	---

POLYURETHANE SPRING BUSHES

Bush Kit			719UK	1
----------	--	--	--------------	---

GREASABLE SHACKLES AND PINS

Greasable Shackle	Left Hand Side		353LH	1
Greasable Shackle	Right Hand Side		353RH	1
Greasable Pin			351	2

LOAD PLUS

Load Plus Helper Springs			LP4	1
--------------------------	--	--	------------	---

CONTINUED NEXT PAGE



Product	Part No.	Qty Req
---------	----------	---------

SUSPENSION KIT

Comfort Petrol w/ Gas Shocks	TOY006AKG
Comfort Petrol w/ Foam Cell	TOY006AKF
Comfort Petrol w/ Foam Cell Pro	TOY006AKP
Comfort Diesel w/ Gas Shocks	TOY006AKG1
Comfort Diesel w/ Foam Cell	TOY006AKF1
Comfort Diesel w/ Foam Cell Pro	TOY006AKP1
Performance Petrol w/ Gas Shocks	TOY006BKG1
Performance Petrol w/ Foam Cell	TOY006BKF1
Performance Petrol w/ Foam Cell Pro	TOY006BKP1
Performance Diesel w/ Gas Shocks	TOY006CKG1
Performance Diesel w/ Foam Cell	TOY006CKF1
Performance Diesel w/ Foam Cell Pro	TOY006CKP1
Constant Load Petrol w/ Gas Shocks	TOY007BKG1
Constant Load Petrol w/ Foam Cell	TOY007BKF1
Constant Load Petrol w/ Foam Cell Pro	TOY007BKP1
Constant Load Diesel w/ Gas Shocks	TOY007CKG1
Constant Load Diesel w/ Foam Cell	TOY007CKF1
Constant Load Diesel w/ Foam Cell Pro	TOY007CKP1

SUSPENSION KIT CONTENTS

Shock Absorbers	U-Bolts
Leaf Springs	Polyurethane Spring Bushes

LANDCRUISER

60 Series
1986+

Product	Part No.	Qty Req
---------	----------	---------

FRONT SUSPENSION**SHOCK ABSORBER**

Nitro Gas Comfort	12637GRC	2
Nitro Gas	12637GR	2
Foam Cell Comfort	24637FEC	2
Foam Cell	24637FE	2
Foam Cell Pro Comfort	45637FEC	2
Foam Cell Pro	45637FE	2

LEAF SPRINGS	Estimated Lift	Additional Load		
Petrol	50mm	0 - 80kg	TOY006B	2
Diesel or Bullbar	50mm	50 - 100kg	TOY006C	2
Turbo Diesel	50mm	50 - 100kg	TOY006D	2

STEERING DAMPER

Foam Cell	3524	1
-----------	-------------	---

U-BOLTS

U-Bolt Kit	436UBK	2
------------	---------------	---

POLYURETHANE SPRING BUSHES

Bush Kit	719UK	1
----------	--------------	---

GREASABLE SHACKLES AND PINS

Greasable Shackle	Left Hand Side	348LH	1
Greasable Shackle	Right Hand Side	348RH	1
Greasable Pin		351	2

REAR SUSPENSION**SHOCK ABSORBER**

Nitro Gas Comfort	12650GRC	2
Nitro Gas	12650GR	2
Foam Cell Comfort	24650FEC	2
Foam Cell	24650FE	2
Foam Cell Pro Comfort	45650FEC	2
Foam Cell Pro	45650FE	2

LEAF SPRINGS	Estimated Lift	Additional Load		
Comfort Drivers side	50mm	0 - 200kg	TOY007AD/S	1
Comfort Near side	50mm	0 - 200kg	TOY007AN/S	1
Performance Drivers side	50mm	0 - 200kg	TOY007BD/S	1
Performance Near side	50mm	0 - 200kg	TOY007BN/S	1
Constant Load Drivers side	50mm	200kg - GVM	TOY007CD/S	1
Constant Load Near side	50mm	200kg - GVM	TOY007CN/S	1

• Side hinge barn door models may require (D/S-D/S) or (N/S-N/S) rear spring configuration to maintain level

U-BOLTS

U-Bolt Kit	415UBK	2
------------	---------------	---

POLYURETHANE SPRING BUSHES

Bush Kit	719UK	1
----------	--------------	---

GREASABLE SHACKLES AND PINS

Greasable Shackle	Left Hand Side	353LH	1
Greasable Shackle	Right Hand Side	353RH	1
Greasable Pin		351	2

LOAD PLUS

Load Plus Helper Springs	LP4	1
--------------------------	------------	---

CONTINUED NEXT PAGE

**Product****Part No.****Qty Req****SUSPENSION KIT**

Comfort Petrol w/ Gas Shocks	TOY006AKG3
Comfort Petrol w/ Foam Cell	TOY006AKF3
Comfort Petrol w/ Foam Cell Pro	TOY006AKP3
Comfort Diesel w/ Gas Shocks	TOY006AKG2
Comfort Diesel w/ Foam Cell	TOY006AKF2
Comfort Diesel w/ Foam Cell Pro	TOY006AKP2
Performance Petrol w/ Gas Shocks	TOY006BKG2
Performance Petrol w/ Foam Cell	TOY006BKF2
Performance Petrol w/ Foam Cell Pro	TOY006BKP2
Performance Diesel w/ Gas Shocks	TOY006CKG2
Performance Diesel w/ Foam Cell	TOY006CKF2
Performance Diesel w/ Foam Cell Pro	TOY006CKP2
Constant Load Petrol w/ Gas Shocks	TOY007BKG2
Constant Load Petrol w/ Foam Cell	TOY007BKF2
Constant Load Petrol w/ Foam Cell Pro	TOY007BKP2
Constant Load Diesel w/ Gas Shocks	TOY007CKG2
Constant Load Diesel w/ Foam Cell	TOY007CKF2
Constant Load Diesel w/ Foam Cell Pro	TOY007CKP2

SUSPENSION KIT CONTENTS

Shock Absorbers	U-Bolts
Leaf Springs	Polyurethane Spring Bushes

LANDCRUISER70, 73, 74 Series (Leaf, Leaf)
1984-1988

Product	Part No.	Qty Req
---------	----------	---------

FRONT SUSPENSION**SHOCK ABSORBER**

Nitro Gas Comfort	12637GRC	2
Nitro Gas	12637GR	2
Foam Cell Comfort	24637FEC	2
Foam Cell	24637FE	2
Foam Cell Pro Comfort	45637FEC	2
Foam Cell Pro	45637FE	2

LEAF SPRINGS

	Estimated Lift	Additional Load		
Performance	50mm	0 - 100kg	TOY008B	2

STEERING DAMPER

Foam Cell	3524	1
-----------	-------------	---

U-BOLTS

U-Bolt Kit	436UBK	2
------------	---------------	---

POLYURETHANE SPRING BUSHES

Bush Kit	719UK	1
----------	--------------	---

GREASABLE SHACKLES AND PINS

Greasable Shackle	Left Hand Side	348LH	1
Greasable Shackle	Right Hand Side	348RH	1
Greasable Pin		351	2

REAR SUSPENSION**SHOCK ABSORBER**

Nitro Gas Comfort	12650GRC	2
Nitro Gas	12650GR	2
Foam Cell Comfort	24650FEC	2
Foam Cell	24650FE	2
Foam Cell Pro Comfort	45650FEC	2
Foam Cell Pro	45650FE	2

LEAF SPRINGS

	Estimated Lift	Additional Load		
Comfort	50mm	0 - 200kg	TOY007AN/S	2
Performance	50mm	0 - 200kg	TOY007BN/S	2

U-BOLTS

U-Bolt Kit	415UBK	2
------------	---------------	---

POLYURETHANE SPRING BUSHES

Bush Kit	719UK	1
----------	--------------	---

GREASABLE SHACKLES AND PINS

Greasable Shackle	Left Hand Side	353LH	1
Greasable Shackle	Right Hand Side	353RH	1
Greasable Pin		354	2

LOAD PLUS

Load Plus Helper Springs	LP4	1
--------------------------	------------	---

SUSPENSION KIT

Comfort w/ Gas Shocks	TOY016AKG
Comfort w/ Foam Cell	TOY016AKF
Comfort w/ Foam Cell Pro	TOY016AKP
Performance w/ Gas Shocks	TOY016BKG
Performance w/ Foam Cell	TOY016BKF
Performance w/ Foam Cell Pro	TOY016BKP

SUSPENSION KIT CONTENTS

Shock Absorbers	U-Bolts
Leaf Springs	Polyurethane Spring Bushes



Product

Part No.

Qty Req

FRONT SUSPENSION

SHOCK ABSORBER

Nitro Gas			12091GR	2
Foam Cell			24091FE	2

COIL SPRINGS

Estimated Lift

Additional Load

Performance	50mm	0 - 50kg	TOY018B	1
-------------	------	----------	----------------	---

STEERING DAMPER

Foam Cell			3524	1
-----------	--	--	-------------	---

REAR SUSPENSION

SHOCK ABSORBER

Nitro Gas	Left Hand Side		12639GRS	1
Nitro Gas	Right Hand Side		12650GR	1
Foam Cell	Left Hand Side		24639FES	1
Foam Cell	Right Hand Side		24650FE	1

COIL SPRINGS

Estimated Lift

Additional Load

Performance	50mm	0 - 200kg	TOY019B	1
-------------	------	-----------	----------------	---

SUSPENSION KIT

Performance w/ Gas Shocks			TOY018BKG	
Performance w/ Foam Cell			TOY018BKF	

SUSPENSION KIT CONTENTS

Shock Absorbers	Coil Springs
-----------------	--------------

LANDCRUISER II

Prado 70, 73, 78 Series
1990-1996



Product	Part No.	Qty Req
---------	----------	---------

FRONT SUSPENSION

SHOCK ABSORBER

Nitro Gas		12696GR	2
Foam Cell		24696FE	2

COIL SPRINGS

	Estimated Lift	Additional Load		
--	----------------	-----------------	--	--

Performance	50mm	0 - 50kg	TOY048B	1
Constant Load	50mm	50 - 100kg	TOY048C	1

STEERING DAMPER

Foam Cell		3524	1
-----------	--	-------------	---

REAR SUSPENSION

SHOCK ABSORBER

Nitro Gas		12697GR	2
Foam Cell		24697FE	2

COIL SPRINGS

	Estimated Lift	Additional Load		
--	----------------	-----------------	--	--

Performance MWB	50mm	0 - 150kg	TOY049B	1
Constant Load or LWB	50mm	50 - 300kg	TOY049C	1

SUSPENSION KIT

Performance w/ Gas Shocks	TOY048BKG
Performance w/ Foam Cell	TOY048BKF
Constant Load w/ Gas Shocks	TOY048CKG
Constant Load w/ Foam Cell	TOY048CKF

SUSPENSION KIT CONTENTS

Shock Absorbers	Coil Springs
-----------------	--------------



Product

Part No.

Qty Req

FRONT SUSPENSION

SHOCK ABSORBER

Nitro Gas			12091GR	2
Foam Cell			24091FE	2
Foam Cell Pro			45091FE	2

COIL SPRINGS

	Estimated Lift	Additional Load		
Performance	40mm	0 - 50kg	TOY046A	1
Performance	50mm	0 - 50kg	TOY046B	1
Constant Load	50mm	50 - 110kg	TOY046C	1

STEERING DAMPER

Foam Cell			3524	1
-----------	--	--	------	---

CASTER CORRECTION

2° Offset Bush Kit			1144SK	1
Adjustable STD, 2.5, 3.5 Degree Offset			1144	1

PANHARD ROD

Adjustable Panhard Rod			PANHARD013	1
------------------------	--	--	------------	---

SWAY BAR LINK

Extended Sway Bar Link			SBEXT001	2
------------------------	--	--	----------	---

COIL SPACER

Polyurethane 30mm			LC70F30	2
-------------------	--	--	---------	---

REAR SUSPENSION

SHOCK ABSORBER

Nitro Gas Comfort			12081GRC	2
Nitro Gas			12081GR	2
Foam Cell Comfort			24081FEC	2
Foam Cell			24081FE	2
Foam Cell Pro Comfort			45081FEC	2
Foam Cell Pro			45081FE	2

LEAF SPRINGS

	Estimated Lift	Additional Load		
Comfort	50mm	0 - 150kg	TOY007AD/S	2
Performance	50mm	0 - 250kg	TOY007BD/S	2
Constant Load	50mm	250kg - GVM	TOY007CD/S	2

U-BOLTS

U-Bolt Kit			415UBK	2
------------	--	--	--------	---

POLYURETHANE SPRING BUSHES

Bush Kit			1185UK	1
----------	--	--	--------	---

GREASABLE SHACKLES AND PINS

Greasable Shackle			1141-1	2
Greasable Shackle	Extra long		1141	2
Greasable Pin			1142	2

SUSPENSION KIT

Comfort w/ Gas Shocks			TOY058AKG
Comfort w/ Foam Cell			TOY058AKF
Comfort w/ Foam Cell Pro			TOY058AKP
Performance w/ Gas Shocks			TOY058BKG
Performance w/ Foam Cell			TOY058BKF
Performance w/ Foam Cell Pro			TOY058BKP
Constant Load w/ Gas Shocks			TOY058CKG
Constant Load w/ Foam Cell			TOY058CKF
Constant Load w/ Foam Cell Pro			TOY058CKP

SUSPENSION KIT CONTENTS

Shock Absorbers	U-Bolts
Coil Springs	Polyurethane Spring Bushes
Leaf Springs	

LANDCRUISER

75 Series
1984-1999

Product	Part No.	Qty Req
---------	----------	---------

FRONT SUSPENSION**SHOCK ABSORBER**

Nitro Gas Comfort	12637GRC	2
Nitro Gas	12637GR	2
Foam Cell Comfort	24637FEC	2
Foam Cell	24637FE	2
Foam Cell Pro Comfort	45637FEC	2
Foam Cell Pro	45637FE	2

LEAF SPRINGS**Estimated Lift****Additional Load**

Performance	50mm	0 - 50kg	TOY008B	2
Constant Load	50mm	50 - 100kg	TOY008C	2

STEERING DAMPER

Foam Cell	3524	1
-----------	------	---

U-BOLTS

U-Bolt Kit	436UBK	2
------------	--------	---

POLYURETHANE SPRING BUSHES

Bush Kit	719UK	1
----------	-------	---

GREASABLE SHACKLES AND PINS

Greasable Shackle	Left Hand Side	348LH	1
Greasable Shackle	Right Hand Side	348RH	1
Greasable Pin		351	2

REAR SUSPENSION**SHOCK ABSORBER**

Nitro Gas Comfort	12081GRC	2
Nitro Gas	12081GR	2
Foam Cell Comfort	24081FEC	2
Foam Cell	24081FE	2
Foam Cell Pro Comfort	45081FEC	2
Foam Cell Pro	45081FE	2

LEAF SPRINGS**Estimated Lift****Additional Load**

Performance	50mm	0 - 200kg	TOY009B	2
Constant Load	50mm	200 - 400kg	TOY009C	2
Extra Constant Load	50mm	400 - 600kg	TOY009D	2
Extra Heavy Constant Load	50mm	600kg - GVM	TOY009E	2

U-BOLTS

U-Bolt Kit	416UBK	2
------------	--------	---

POLYURETHANE SPRING BUSHES

Bush Kit	720UK	1
----------	-------	---

GREASABLE SHACKLES AND PINS

Greasable Shackle	Left Hand Side	353LH	1
Greasable Shackle	Right Hand Side	353RH	1
Greasable Pin		354	2

LOAD PLUS

Load Plus Helper Springs	Drum Brake Models Only	LP4	1
--------------------------	------------------------	-----	---

SUSPENSION KIT

Performance w/ Gas Shocks	TOY008BKG
Performance w/ Foam Cell	TOY008BKF
Performance w/ Foam Cell Pro	TOY008BKP
Constant Load w/ Gas Shocks	TOY008CKG
Constant Load w/ Foam Cell	TOY008CKF
Constant Load w/ Foam Cell Pro	TOY008CKP
Extra Constant Load w/ Gas Shocks	TOY009DKG
Extra Constant Load w/ Foam Cell	TOY009DKF
Extra Constant Load w/ Foam Cell Pro	TOY009DKP
Extra Heavy Constant Load w/ Gas Shocks	TOY009EKG
Extra Heavy Constant Load w/ Foam Cell	TOY009EKF
Extra Heavy Constant Load w/ Foam Cell Pro	TOY009EKP

SUSPENSION KIT CONTENTS

Shock Absorbers	U-Bolts
Leaf Springs	Polyurethane Spring Bushes



Product **Part No.** **Qty Req**

FRONT SUSPENSION

SHOCK ABSORBER

Nitro Gas			12091GR	2
Foam Cell			24091FE	2
Foam Cell Pro			45091FE	2

COIL SPRINGS

	Estimated Lift	Additional Load		
Performance	40mm	0 - 50kg	TOY046A	1
Performance	50mm	0 - 50kg	TOY046B	1
Constant Load	50mm	50 - 110kg	TOY046C	1

STEERING DAMPER

Foam Cell			3525	1
-----------	--	--	------	---

CASTER CORRECTION

2° Offset Bush Kit			1144SK	1
Adjustable Offset STD, 2.5, 3.5 Degree			1144	1

PANHARD ROD

Adjustable Panhard Rod			PANHARD013	1
------------------------	--	--	------------	---

SWAY BAR LINK

Extended Sway Bar Link			SBEXT001	2
------------------------	--	--	----------	---

COIL SPACER

Polyurethane 30mm			LC70F30	2
-------------------	--	--	---------	---

REAR SUSPENSION

SHOCK ABSORBER

Nitro Gas			12094GR	2
Foam Cell			24094FE	2
Foam Cell Extra Long			24094LFE	2
Foam Cell Pro			45094FE	2
Foam Cell Pro Extra Long			45094LFE	2

LEAF SPRINGS

	Estimated Lift	Additional Load		
Performance	50mm	0 - 300kg	TOY062B	2
Constant Load	50mm	300 - 600kg	TOY062C	2
Extra Constant Load	50mm	600kg - GVM	TOY062D	2

U-BOLTS

U-Bolt Kit			416UBK	2
------------	--	--	--------	---

POLYURETHANE SPRING BUSHES

Bush Kit			1085UK	1
----------	--	--	--------	---

GREASABLE SHACKLES AND PINS

Greasable Shackle			1141-1	2
Greasable Shackle Extended 20mm			1141	2
Greasable Pin			1142	2

LOAD PLUS

Load Plus Helper Springs			LP4	1
--------------------------	--	--	-----	---

SUSPENSION KIT

Performance w/ Gas Shocks	TOY062BKG
Performance w/ Foam Cell	TOY062BKF
Performance w/ Foam Cell Pro	TOY062BKP
Constant Load w/ Gas Shocks	TOY062CKG
Constant Load w/ Foam Cell	TOY062CKF
Constant Load w/ Foam Cell Pro	TOY062CKP
Extra Constant Load w/ Gas Shocks	TOY062DKG
Extra Constant Load w/ Foam Cell	TOY062DKF
Extra Constant Load w/ Foam Cell Pro	TOY062DKP

SUSPENSION KIT CONTENTS

Shock Absorbers	U-Bolts
Coil Springs	Polyurethane Spring Bushes
Leaf Springs	

LANDCRUISER

78 Series
1999+

Product	Part No.	Qty Req
---------	----------	---------

FRONT SUSPENSION**SHOCK ABSORBER**

Nitro Gas		12091GR	2
Foam Cell		24091FE	2
Foam Cell Pro		45091FE	2

COIL SPRINGS**Estimated Lift****Additional Load**

Comfort	40mm	0 - 50kg	TOY046A	1
Performance	50mm	0 - 50kg	TOY046B	1
Constant Load	50mm	50 - 110kg	TOY046C	1

STEERING DAMPER

Foam Cell	1999-2006	3524	1
Foam Cell	2007+	3525	1

CASTER CORRECTION

2° Offset Bush Kit		1144SK	1
Adjustable Offset STD, 2.5, 3.5 Degree		1144	1

PANHARD ROD

Adjustable Panhard Rod		PANHARD013	1
------------------------	--	-------------------	---

SWAY BAR LINK

Extended Sway Bar Link		SBEXT001	2
------------------------	--	-----------------	---

COIL SPACER

Polyurethane 30mm		LC70F30	2
-------------------	--	----------------	---

REAR SUSPENSION**SHOCK ABSORBER**

Nitro Gas		12094GR	2
Foam Cell		24094FE	2
Foam Cell Extra Long		24094LFE	2
Foam Cell Pro		45094FE	2
Foam Cell Pro Extra Long		45094LFE	2

LEAF SPRINGS**Estimated Lift****Additional Load**

Comfort	50mm	0 - 150kg	TOY047A	2
Performance	50mm	0 - 250kg	TOY047B	2
Constant Load	50mm	250 - 400kg	TOY047C	2
Extra Constant Load	50mm	400kg - 600kg	TOY047D	2
Extra Heavy Constant Load	50mm	600kg - GVM	TOY047E	2

U-BOLTS

U-Bolt Kit		416UBK	2
U-Bolt Kit Extra Long	Suit TOY047D and TOY047E Spring	416UBKL	2

POLYURETHANE SPRING BUSHES

Bush Kit		1084UK	1
----------	--	---------------	---

GREASABLE SHACKLES AND PINS

Greasable Shackle		1141	2
Greasable Pin		1142	2

LOAD PLUS

Load Plus Helper Springs	Drum Brake Models Only	LP9	1
--------------------------	------------------------	------------	---

CONTINUED NEXT PAGE



Product	Part No.	Qty Req
---------	----------	---------

SUSPENSION KIT

Comfort w/ Gas Shocks	TOY046AKG
Comfort w/ Foam Cell	TOY046AKF
Comfort w/ Foam Cell Pro	TOY046AKP
Performance w/ Gas Shocks	TOY046BKG
Performance w/ Foam Cell	TOY046BKF
Performance w/ Foam Cell Pro	TOY046BKP
Constant Load w/ Gas Shocks	TOY046CKG
Constant Load w/ Foam Cell	TOY046CKF
Constant Load w/ Foam Cell Pro	TOY046CKP
Extra Constant Load w/ Gas Shocks	TOY046DKG
Extra Constant Load w/ Foam Cell	TOY046DKF
Extra Constant Load w/ Foam Cell Pro	TOY046DKP
Extra Heavy Constant Load w/ Foam Cell	TOY046EKF
Extra Heavy Constant Load w/ Foam Cell Pro	TOY046EKP

GVM UPGRADE

Pre Registration	Temporary Load	TOY047CKFGVM
Post Registration	Temporary Load	TOY047CKFGVM1
Pre Registration	Permanent Load	TOY047DKFGVM
Post Registration	Permanent Load	TOY047DKFGVM1

- Australian Customers Only
- Only available through authorised Ironman 4x4 GVM upgrade installers

SUSPENSION KIT CONTENTS

Shock Absorbers	U-Bolts
Coil Springs	Polyurethane Spring Bushes
Leaf Springs	

GVM UPGRADE KIT CONTENTS

Shock Absorbers	Polyurethane Spring Bushes
Coil Springs	Greasable Shackles
Leaf Springs	Compliance Plate
U-Bolts	Tyre Placard

LANDCRUISER

79 Series
1999+

Product	Part No.	Qty Req
---------	----------	---------

FRONT SUSPENSION**SHOCK ABSORBER**

Nitro Gas		12091GR	2
Foam Cell		24091FE	2
Foam Cell Pro		45091FE	2

COIL SPRINGS**Estimated Lift****Additional Load**

	Estimated Lift	Additional Load	Part No.	Qty Req
Comfort	40mm	0 - 50kg	TOY046A	1
Performance	50mm	0 - 50kg	TOY046B	1
Constant Load	50mm	50 - 110kg	TOY046C	1

STEERING DAMPER

Foam Cell	1999-2006	3524	1
Foam Cell	2007+	3525	1

CASTER CORRECTION

2° Offset Bush Kit	1144SK	1
Adjustable Offset STD, 2.5, 3.5 Degree	1144	1

PANHARD ROD

Adjustable Panhard Rod	PANHARD013	1
------------------------	-------------------	---

SWAY BAR LINK

Extended Sway Bar Link	SBEXT001	2
------------------------	-----------------	---

COIL SPACER

Polyurethane 30mm	LC70F30	2
-------------------	----------------	---

REAR SUSPENSION**SHOCK ABSORBER**

Nitro Gas	12094GR	2
Foam Cell	24094FE	2
Foam Cell Extra Long	24094LFE	2
Foam Cell Pro	45094FE	2
Foam Cell Pro Extra Long	45094LFE	2

LEAF SPRINGS**Estimated Lift****Additional Load**

	Estimated Lift	Additional Load	Part No.	Qty Req
Comfort	50mm	0 - 150kg	TOY047A	2
Performance	50mm	0 - 250kg	TOY047B	2
Constant Load	50mm	250 - 400kg	TOY047C	2
Extra Constant Load	50mm	400kg - 600kg	TOY047D	2
Extra Heavy Constant Load	50mm	600kg - GVM	TOY047E	2

U-BOLTS

U-Bolt Kit		416UBK	2
U-Bolt Kit Extra Long	Suit TOY047D and TOY047E Spring	416UBKL	2

POLYURETHANE SPRING BUSHES

Bush Kit	1085UK	1
----------	---------------	---

GREASABLE SHACKLES AND PINS

Greasable Shackle	1141	2
Greasable Pin	1142	2

LOAD PLUS

Load Plus Helper Springs	Drum Brake Models Only	LP9	1
--------------------------	------------------------	------------	---

CONTINUED NEXT PAGE



Product

Part No.

Qty Req

SUSPENSION KIT

Comfort w/ Gas Shocks	TOY046AKG1
Comfort w/ Foam Cell	TOY046AKF1
Comfort w/ Foam Cell Pro	TOY046AKP1
Performance w/ Gas Shocks	TOY046BKG1
Performance w/ Foam Cell	TOY046BKF1
Performance w/ Foam Cell Pro	TOY046BKP1
Constant Load w/ Gas Shocks	TOY046CKG1
Constant Load w/ Foam Cell	TOY046CKF1
Constant Load w/ Foam Cell Pro	TOY046CKP1
Extra Constant Load w/ Gas Shocks	TOY046DKG1
Extra Constant Load w/ Foam Cell	TOY046DKF1
Extra Constant Load w/ Foam Cell Pro	TOY046DKP1
Extra Heavy Constant Load w/ Foam Cell	TOY046EKF1
Extra Heavy Constant Load w/ Foam Cell Pro	TOY046EKP1

GVM UPGRADE

Pre Registration	Temporary Load	TOY047CKFGVM
Post Registration	Temporary Load	TOY047CKFGVM1
Pre Registration	Permanent Load	TOY047DKFGVM
Post Registration	Permanent Load	TOY047DKFGVM1

• Australian Customers Only

• Only available through authorised Ironman 4x4 GVM upgrade installers



SUSPENSION KIT CONTENTS

Shock Absorbers	U-Bolts
Coil Springs	Polyurethane Spring Bushes
Leaf Springs	

GVM UPGRADE KIT CONTENTS

Shock Absorbers	Polyurethane Spring Bushes
Coil Springs	Greasable Shackles
Leaf Springs	Compliance Plate
U-Bolts	Tyre Placard

LANDCRUISER

79 Series Dual Cab
2013+

Product	Part No.	Qty Req
---------	----------	---------

FRONT SUSPENSION**SHOCK ABSORBER**

Nitro Gas	12091GR	2
Foam Cell	24091FE	2
Foam Cell Pro	45091FE	2

COIL SPRINGS	Estimated Lift	Additional Load		
Comfort	40mm	0 - 50kg	TOY046A	1
Performance	50mm	0 - 50kg	TOY046B	1
Constant Load	50mm	50 - 110kg	TOY046C	1

STEERING DAMPER

Foam Cell	3525	1
-----------	-------------	---

CASTER CORRECTION

2° Offset Bush Kit	1144SK	1
Adjustable Offset STD, 2.5, 3.5 Degree	1144	1

PANHARD ROD

Adjustable Panhard Rod	PANHARD013	1
------------------------	-------------------	---

SWAY BAR LINK

Extended Sway Bar Link	SBEXT001	2
------------------------	-----------------	---

COIL SPACER

Polyurethane 30mm	LC70F30	2
-------------------	----------------	---

REAR SUSPENSION**SHOCK ABSORBER**

Nitro Gas	12094GR	2
Foam Cell	24094FE	2
Foam Cell Extra Long	24094LFE	2
Foam Cell Pro	45094FE	2
Foam Cell Pro Extra Long	45094LFE	2

LEAF SPRINGS	Estimated Lift	Additional Load		
Comfort	50mm	0 - 250kg	TOY047B	2
Performance	50mm	0 - 300kg	TOY047C	2
Constant Load	50mm	300kg - 500kg	TOY047D	2
Extra Constant Load	50mm	500kg - GVM	TOY047E	2

U-BOLTS

U-Bolt Kit		416UBK	2
U-Bolt Kit Extra Long	Suit TOY047D and TOY047E Spring	416UBKL	2

POLYURETHANE SPRING BUSHES

Bush Kit	1085UK	1
----------	---------------	---

GREASABLE SHACKLES AND PINS

Greasable Shackle	1141	2
Greasable Pin	1142	2

LOAD PLUS

Load Plus Helper Springs	Drum Brake Models Only	LP9	1
--------------------------	------------------------	------------	---

CONTINUED NEXT PAGE



Product	Part No.	Qty Req
---------	----------	---------

SUSPENSION KIT

Comfort w/ Gas Shocks	TOY046BKG1	
Comfort w/ Foam Cell	TOY046BKF1	
Comfort w/ Foam Cell Pro	TOY046BKP1	
Performance w/ Gas Shocks	TOY046CKG1	
Performance w/ Foam Cell	TOY046CKF1	
Performance w/ Foam Cell Pro	TOY046CKP1	
Constant Load w/ Gas Shocks	TOY046DKG1	
Constant Load w/ Foam Cell	TOY046DKF1	
Constant Load w/ Foam Cell Pro	TOY046DKP1	
Extra Constant Load w/ Foam Cell	TOY046EKF1	
Extra Constant Load w/ Foam Cell Pro	TOY046EKP1	

GVM UPGRADE

Pre Registration	Temporary Load	TOY047CKFGVM
Post Registration	Temporary Load	TOY047CKFGVM1
Pre Registration	Permanent Load	TOY047DKFGVM
Post Registration	Permanent Load	TOY047DKFGVM1

• Australian Customers Only

• Only available through authorised Ironman 4x4 GVM upgrade installers



SUSPENSION KIT CONTENTS

Shock Absorbers	U-Bolts
Coil Springs	Polyurethane Spring Bushes
Leaf Springs	

GVM UPGRADE KIT CONTENTS

Shock Absorbers	Polyurethane Spring Bushes
Coil Springs	Greasable Shackles
Leaf Springs	Compliance Plate
U-Bolts	Tyre Placard

LANDCRUISER

80 Series
1990+

Product	Part No.	Qty Req
---------	----------	---------

FRONT SUSPENSION**SHOCK ABSORBER**

Nitro Gas		12683GR	2
Foam Cell		24683FE	2
Foam Cell Pro		45683FE	2
Foam Cell	Suits 4" Lift	24683LFE	2
Foam Cell Pro	Suits 4" Lift	45683LFE	2
Foam Cell	Suits 6" Lift	24683LFE1	2
Foam Cell Pro	Suits 6" Lift	45683LFE1	2

COIL SPRINGS

	Estimated Lift	Additional Load		
Performance	50mm	0 - 50kg	TOY024B	1
Constant Load	50mm	50 - 110kg	TOY024C	1
Performance 4" Lift	100mm	0 - 100kg	TOY012C	1
Performance 6" Lift	150mm	0 - 100kg	TOY060B	1

STEERING DAMPER

Foam Cell		3524	1
-----------	--	-------------	---

CASTER CORRECTION

2° Offset Bush Kit		1144SK	1
Adjustable Offset STD, 2.5, 3.5°		1144	1
5° Offset Plate Kit		CPLATE001	1

DRAG LINK

Adjustable Drag Link	Right Hand Drive	ADL001	1
----------------------	------------------	---------------	---

ADJUSTABLE PANHARD ROD

Right Hand Drive Rod		PANHARD001	1
Left Hand Drive Rod		PANHARD007	1

SWAY BAR LINK

Extended Sway Bar Link		SBEXT001	2
------------------------	--	-----------------	---

COIL SPACER

Polyurethane 20mm		LCF20	2
Polyurethane 30mm		LCF30	2

EXTENDED BRAKE HOSE

Single Hose Models		BHOSE001	1
Dual Hose Models		BHOSE002	2

REAR SUSPENSION**SHOCK ABSORBER**

Nitro Gas		12682GR	2
Foam Cell		24682FE	2
Foam Cell Pro		45682FE	2
Foam Cell	Suits 4" Lift	24682LFE	2
Foam Cell Pro	Suits 4" Lift	45682LFE	2
Foam Cell	Suits 6" Lift	24682LFE1	2
Foam Cell Pro	Suits 6" Lift	45682LFE1	2

COIL SPRINGS

	Estimated Lift	Additional Load		
Performance	50mm	0 - 200kg	TOY025B	1
Performance w/ Accessories	50mm	100 - 300kg	TOY013B	1
Constant Load	50mm	200 - 400kg	TOY025C	1
Extra constant Load	55mm	400 - 500kg	TOY025D	1
Performance 4" Lift	100mm	0 - 300kg	TOY013C	1
Performance 6" Lift	150mm	0 - 300kg	TOY061B	1
Constant Load 4" Lift	100mm	300 - 500kg	TOY013D	1
Constant Load 6" Lift	150mm	300 - 500kg	TOY061C	1

CONTINUED NEXT PAGE



Product	Part No.	Qty Req	
PANHARD ROD			
Adjustable Panhard Rod	PANHARD002	1	
ADJUSTABLE TRAILING ARM			
Upper Trailing Arm	UTA001	2	
Lower Trailing Arm	LTA001	2	
SWAY BAR LINK			
Extended Sway Bar Link	Side Mount	SBEXT002	2
Extended Sway Bar Link	Under Mount	SBEXT005	2
COIL SPACER			
Polyurethane 15mm	LCR15	2	
Polyurethane 30mm	LCR30	2	
BRAKE HOSE			
Extended Brake Hose	BHOSE002	1	
BUSH KIT			
Polyurethane Suspension Arm Bush Kit	847K	1	
SUSPENSION KIT			
Performance w/ Gas Shocks	TOY024BKG		
Performance w/ Foam Cell	TOY024BKF		
Performance w/ Foam Cell Pro	TOY024BKP		
Constant Load w/ Gas Shocks	TOY024BKG		
Constant Load w/ Foam Cell	TOY024BKF		
Constant Load w/ Foam Cell Pro	TOY024BKP		
Extra Constant Load w/ Gas Shocks	TOY024BKG		
Extra Constant Load w/ Foam Cell	TOY024BKF		
Extra Constant Load w/ Foam Cell Pro	TOY024BKP		
Performance w/ Foam Cell	4"Lift	Right Hand Drive	TOY012CKF1
Performance w/ Foam Cell Pro	4"Lift	Right Hand Drive	TOY012CKP1
Performance w/ Foam Cell	6"Lift	Right Hand Drive	TOY063BKF1
Performance w/ Foam Cell Pro	6"Lift	Right Hand Drive	TOY063BKP1
Performance w/ Foam Cell	4"Lift	Left Hand Drive	TOY012CKF1L
Performance w/ Foam Cell Pro	4"Lift	Left Hand Drive	TOY012CKP1L
Performance w/ Foam Cell	6"Lift	Left Hand Drive	TOY063BKF1L
Performance w/ Foam Cell Pro	6"Lift	Left Hand Drive	TOY063BKP1L
Constant Load w/ Foam Cell	4"Lift	Right Hand Drive	TOY012CKF2
Constant Load w/ Foam Cell Pro	4"Lift	Right Hand Drive	TOY012CKP2
Constant Load w/ Foam Cell	6"Lift	Right Hand Drive	TOY063BKF2
Constant Load w/ Foam Cell Pro	6"Lift	Right Hand Drive	TOY063BKP2
Constant Load w/ Foam Cell	4"Lift	Left Hand Drive	TOY012CKF2L
Constant Load w/ Foam Cell Pro	4"Lift	Left Hand Drive	TOY012CKP2L
Constant Load w/ Foam Cell	6"Lift	Left Hand Drive	TOY063BKF2L
Constant Load w/ Foam Cell Pro	6"Lift	Left Hand Drive	TOY063BKP2L

50MM SUSPENSION KIT CONTENTS

Shock Absorbers
Coil Springs

4" AND 6" SUSPENSION KIT CONTENTS

Shock Absorbers
Coil Springs
Panhard Rods

Sway Bar Links
Caster Plates
Brake Hoses

Adjustable Trailing Arms

FOAMCELL PRO BIG LIFT SUSPENSION KITS



**Fully integrated
4" and 6" lifts
to suit Toyota
Landcruiser
80/105**

Kits Include

- Coil Springs
- Foam Cell Pro Shock Absorbers
- Adjustable Panhard Rods
- Adjustable Trailing Arms
- Caster Correction Plates
- Extended Sway Bar Links
- Extended Brake Hoses

Kit components are also available individually

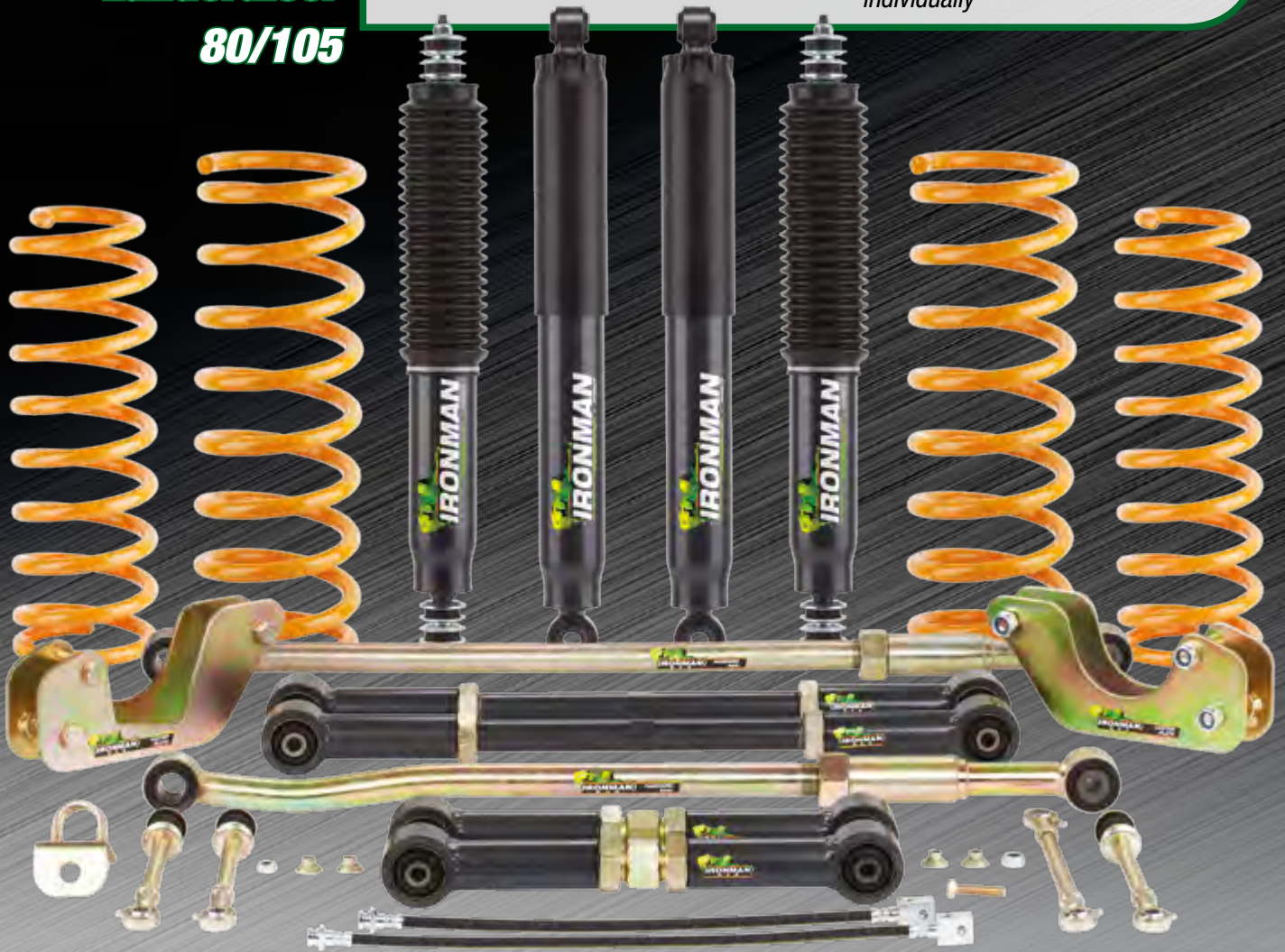

Toyota Landcruiser 80/105

**4" and 6" lifts are designed for off-road competition use.
Certification may be required for on-road use.**



Product

Part No.

Qty Req

FRONT SUSPENSION

SHOCK ABSORBER

Nitro Gas			12795GR	2
Foam Cell			24795FE	2
Foam Cell Pro			45795FE	2

TORSION BAR

Uprated Torsion Bars	Petrol Models	1160mm Length	TOY050	1
Uprated Torsion Bars	Diesel Models	1210mm Length	TOY051	1

- *Must Install BRACKET100*
- *Some Middle Eastern Petrol models use TOY051, check length before ordering*
- *Minimum 60mm downward suspension travel required*

CONTROL ARM

Control Arm Reinforcement			BRACKET100	1
---------------------------	--	--	-------------------	---

REAR SUSPENSION

SHOCK ABSORBER

Nitro Gas			12796GR	2
Foam Cell			24796FE	2
Foam Cell Pro			45796FE	2

COIL SPRINGS

	Estimated Lift	Additional Load		
Performance	25mm	0 - 200kg	TOY013B	1
Constant Load	25mm	200 - 400kg	TOY025C	1

COIL SPACER

Polyurethane 15mm			LCR15	2
Polyurethane 30mm			LCR30	2

SUSPENSION KIT

Performance Petrol w/ Gas Shocks	TOY050BKG
Performance Petrol w/ Foam Cell	TOY050BKF
Performance Petrol w/ Foam Cell Pro	TOY050BKP
Constant Load Petrol w/ Gas Shocks	TOY050CKG
Constant Load Petrol w/ Foam Cell	TOY050CKF
Constant Load Petrol w/ Foam Cell Pro	TOY050CKP
Performance Diesel w/ Gas Shocks	TOY051BKG
Performance Diesel w/ Foam Cell	TOY051BKF
Performance Diesel w/ Foam Cell Pro	TOY051BKP
Constant Load Diesel w/ Gas Shocks	TOY051CKG
Constant Load Diesel w/ Foam Cell	TOY051CKF
Constant Load Diesel w/ Foam Cell Pro	TOY051CKP

- *Some Middle Eastern Petrol models use TOY051, check Torsion Bar length before ordering*

SUSPENSION KIT CONTENTS

Shock Absorbers	Torsion Bars
Coil Springs	Control Arm Reinforcement

LANDCRUISER

105 Series
1998+

Product	Part No.	Qty Req
---------	----------	---------

FRONT SUSPENSION**SHOCK ABSORBER**

Nitro Gas		12683GR	2
Foam Cell		24683FE	2
Foam Cell Pro		45683FE	2
Foam Cell	Suits 4" Lift	24683LFE	2
Foam Cell Pro	Suits 4" Lift	45683LFE	2
Foam Cell	Suits 6" Lift	24683LFE1	2
Foam Cell Pro	Suits 6" Lift	45683LFE1	2

COIL SPRINGS

	Estimated Lift	Additional Load		
Performance	50mm	0 - 50kg	TOY024B	1
Constant Load	50mm	50 - 110kg	TOY024C	1
Performance 4" Lift	100mm	0 - 100kg	TOY012C	1
Performance 6" Lift	150mm	0 - 100kg	TOY060B	1

STEERING DAMPER

Foam Cell		3524	1
-----------	--	-------------	---

CASTER CORRECTION

2° Offset Bush Kit		1144SK	1
Adjustable Offset STD, 2.5, 3.5°		1144	1
5° Offset Plate Kit		CPLATE001	1

DRAG LINK

Adjustable Drag Link	Right Hand Drive	ADL001	1
----------------------	------------------	---------------	---

ADJUSTABLE PANHARD ROD

Right Hand Drive Rod		PANHARD001	1
Left Hand Drive Rod		PANHARD007	1

SWAY BAR LINK

Extended Sway Bar Link		SBEXT001	2
------------------------	--	-----------------	---

COIL SPACER

Polyurethane 20mm		LCF20	2
Polyurethane 30mm		LCF30	2

EXTENDED BRAKE HOSE

Single Hose Models		BHOSE001	1
Dual Hose Models		BHOSE002	2

REAR SUSPENSION**SHOCK ABSORBER**

Nitro Gas		12682GR	2
Foam Cell		24682FE	2
Foam Cell Pro		45682FE	2
Foam Cell	Suits 4" Lift	24682LFE	2
Foam Cell Pro	Suits 4" Lift	45682LFE	2
Foam Cell	Suits 6" Lift	24682LFE1	2
Foam Cell Pro	Suits 6" Lift	45682LFE1	2

COIL SPRINGS

	Estimated Lift	Additional Load		
Performance	50mm	0 - 200kg	TOY025B	1
Performance w/ Accessories	50mm	100 - 300kg	TOY013B	1
Constant Load	50mm	200 - 400kg	TOY025C	1
Extra constant Load	55mm	400 - 500kg	TOY025D	1
Performance 4" Lift	100mm	0 - 300kg	TOY013C	1
Performance 6" Lift	150mm	0 - 300kg	TOY061B	1
Constant Load 4" Lift	100mm	300 - 500kg	TOY013D	1
Constant Load 6" Lift	150mm	300 - 500kg	TOY061C	1

CONTINUED NEXT PAGE



Product	Part No.	Qty Req	
PANHARD ROD			
Adjustable Panhard Rod	PANHARD002	1	
ADJUSTABLE TRAILING ARM			
Upper Trailing Arm	UTA001	2	
Lower Trailing Arm	LTA001	2	
SWAY BAR LINK			
Extended Sway Bar Link	Side mount	SBEXT002	2
Extended Sway Bar Link	Under mount	SBEXT005	2
COIL SPACER			
Polyurethane 15mm	LCR15	2	
Polyurethane 30mm	LCR30	2	
BRAKE HOSE			
Extended Brake Hose	BHOSE002	1	
BUSH KIT			
Polyurethane Suspension Arm Bush Kit	847K	1	
SUSPENSION KIT			
Performance w/ Gas Shocks	TOY024BKG		
Performance w/ Foam Cell	TOY024BKF		
Performance w/ Foam Cell Pro	TOY024BKP		
Constant Load w/ Gas Shocks	TOY024BKG		
Constant Load w/ Foam Cell	TOY024BKF		
Constant Load w/ Foam Cell Pro	TOY024BKP		
Extra Constant Load w/ Gas Shocks	TOY024BKG		
Extra Constant Load w/ Foam Cell	TOY024BKF		
Extra Constant Load w/ Foam Cell Pro	TOY024BKP		
Performance w/ Foam Cell	4"Lift	Right hand Drive	TOY012CKF1
Performance w/ Foam Cell Pro	4"Lift	Right hand Drive	TOY012CKP1
Performance w/ Foam Cell	6"Lift	Right hand Drive	TOY063BKF1
Performance w/ Foam Cell Pro	6"Lift	Right hand Drive	TOY063BKP1
Performance w/ Foam Cell	4"Lift	Left hand Drive	TOY012CKF1L
Performance w/ Foam Cell Pro	4"Lift	Left hand Drive	TOY012CKP1L
Performance w/ Foam Cell	6"Lift	Left hand Drive	TOY063BKF1L
Performance w/ Foam Cell Pro	6"Lift	Left hand Drive	TOY063BKP1L
Constant Load w/ Foam Cell	4"Lift	Right hand Drive	TOY012CKF2
Constant Load w/ Foam Cell Pro	4"Lift	Right hand Drive	TOY012CKP2
Constant Load w/ Foam Cell	6"Lift	Right hand Drive	TOY063BKF2
Constant Load w/ Foam Cell Pro	6"Lift	Right hand Drive	TOY063BKP2
Constant Load w/ Foam Cell	4"Lift	Left hand Drive	TOY012CKF2L
Constant Load w/ Foam Cell Pro	4"Lift	Left hand Drive	TOY012CKP2L
Constant Load w/ Foam Cell	6"Lift	Left hand Drive	TOY063BKF2L
Constant Load w/ Foam Cell Pro	6"Lift	Left hand Drive	TOY063BKP2L

50MM SUSPENSION KIT CONTENTS

Shock Absorbers
Coil Springs

4" AND 6" SUSPENSION KIT CONTENTS

Shock Absorbers
Coil Springs
Panhard Rods

Sway Bar Links
Caster Plates
Brake Hoses

Adjustable Trailing Arms

LANDCRUISER

200 Series
2007+

Product	Part No.	Qty Req
---------	----------	---------

FRONT SUSPENSION**SHOCK ABSORBER**

Nitro Gas Strut	12720GR	2
Foam Cell Strut	24720FE	2
Foam Cell Pro Strut	45720FE	2

- Height adjustable with Ironman 4x4 Strut Trim Packers

COIL SPRINGS

	Estimated Lift	Additional Load		
Comfort	25mm	0 - 50kg	TOY063A	1
Performance	50mm	0 - 50kg	TOY063B	1
Constant Load	50mm	50 - 110kg	TOY063C	1

TRIM PACKERS

5mm Strut Trim Packer	(Nitro Gas / Foam Cell)	HILFR05 / HILFR05F	2
10mm Strut Trim Packer	(Nitro Gas / Foam Cell)	HILFR10 / HILFR10F	2
15mm Strut Trim Packer	(Nitro Gas / Foam Cell)	HILFR15 / HILFR15F	2

- ONLY Compatible with Ironman 4x4 Struts (except Pro), lift height subject to 1:2 motion ratio. Unnecessary fitment may lift vehicle too high

SWAY BAR

38mm Sway Bar	Non KDSS Models Only	ISB200F	1
---------------	----------------------	---------	---

REAR SUSPENSION**SHOCK ABSORBER**

Nitro Gas	12796GR	2
Foam Cell	24796FE	2
Foam Cell Pro	45796FE	2

COIL SPRINGS

	Estimated Lift	Additional Load		
Comfort	25mm	0 -200kg	TOY064A	1
Performance	50mm	0 -300kg	TOY064B	1
Performance w/ Accessories	50mm	100 - 400kg	TOY064EA	1
Constant Load	50mm	400kg - GVM	TOY064C	1

SWAY BAR

33mm Sway Bar	Non KDSS Models Only	ISB200R	1
---------------	----------------------	---------	---

SUSPENSION KIT

Comfort w/ Gas Shocks	TOY063AKG
Comfort w/ Foam Cell	TOY063AKF
Comfort w/ Foam Cell Pro	TOY063AKP
Performance w/ Gas Shocks	TOY063BKG
Performance w/ Foam Cell	TOY063BKF
Performance w/ Foam Cell Pro	TOY063BKP
Constant Load w/ Gas Shocks	TOY063CKG
Constant Load w/ Foam Cell	TOY063CKF
Constant Load w/ Foam Cell Pro	TOY063CKP

- All kits compatible with KDSS, refer KDSS instructions for installation

SUSPENSION KIT CONTENTS

Shock Absorbers	Coil Springs
Strut Shock Absorbers	



Product

Part No.

Qty Req

FRONT SUSPENSION

SHOCK ABSORBER

Nitro Gas Strut			12691GR	2
Foam Cell Strut			24691FE	2
Foam Cell Pro Strut			45691FE	2

• Height adjustable with Ironman 4x4 Strut Trim Packers

COIL SPRINGS **Estimated Lift** **Additional Load**

Performance Petrol	45mm	0 - 50kg	TOY038B	1
Constant Load or Diesel	45mm	50 - 110kg	TOY038C	1

TRIM PACKERS

5mm Strut Trim Packer	(Nitro Gas / Foam Cell)		HILFR05 / HILFR05F	2
10mm Strut Trim Packer	(Nitro Gas / Foam Cell)		HILFR10 / HILFR10F	2
15mm Strut Trim Packer	(Nitro Gas / Foam Cell)		HILFR15 / HILFR15F	2

• ONLY Compatible with Ironman 4x4 Struts (except Pro), lift height subject to 1:2 motion ratio. Unnecessary fitment may lift vehicle too high

REAR SUSPENSION

SHOCK ABSORBER

Nitro Gas			12661GR	2
Foam Cell			24661FE	2
Foam Cell Pro			45661FE	2

COIL SPRINGS **Estimated Lift** **Additional Load**

Performance SWB	45mm	0 -300kg	TOY039A	1
Performance LWB	45mm	0- 300kg	TOY039B	1
Constant Load	45mm	300kg - GVM	TOY039C	1

COIL SPACER

Polyurethane 20mm			LCF20	2
Polyurethane 30mm			LCF30	2

SUSPENSION KIT

Performance SWB Petrol w/ Gas Shocks	TOY038AKG
Performance SWB Petrol w/ Foam Cell	TOY038AKF
Performance SWB Petrol w/ Foam Cell Pro	TOY038AKP
Performance SWB Diesel w/ Gas Shocks	TOY038AKG1
Performance SWB Diesel w/ Foam Cell	TOY038AKF1
Performance SWB Diesel w/ Foam Cell Pro	TOY038AKP1
Performance LWB Petrol w/ Gas Shocks	TOY038BKG
Performance LWB Petrol w/ Foam Cell	TOY038BKF
Performance LWB Petrol w/ Foam Cell Pro	TOY038BKP
Performance LWB Diesel w/ Gas Shocks	TOY038CKG
Performance LWB Diesel w/ Foam Cell	TOY038CKF
Performance LWB Diesel w/ Foam Cell Pro	TOY038CKP
Constant Load LWB Petrol w/ Gas Shocks	TOY038BKG1
Constant Load LWB Petrol w/ Foam Cell	TOY038BKF1
Constant Load LWB Petrol w/ Foam Cell Pro	TOY038BKP1
Constant Load LWB Diesel w/ Gas Shocks	TOY038CKG1
Constant Load LWB Diesel w/ Foam Cell	TOY038CKF1
Constant Load LWB Diesel w/ Foam Cell Pro	TOY038CKP1

SUSPENSION KIT CONTENTS

Shock Absorbers	Coil Springs
Strut Shock Absorbers	



Product

Part No.

Qty Req

FRONT SUSPENSION**SHOCK ABSORBER**

Nitro Gas Strut			12710GR	2
Foam Cell Strut			24710FE	2
Foam Cell Pro Strut			45710FE	2

• Height adjustable with Ironman 4x4 Strut Trim Packers

COIL SPRINGS**Estimated Lift****Additional Load**

	Estimated Lift	Additional Load		
Comfort	30mm	0 - 50kg	TOY055A	1
Performance Petrol	45mm	0 - 50kg	TOY055B	1
Constant Load or Diesel	45mm	50 - 110kg	TOY055C	1

TRIM PACKERS

5mm Strut Trim Packer	(Nitro Gas / Foam Cell)	HILFR05 / HILFR05F	2
10mm Strut Trim Packer	(Nitro Gas / Foam Cell)	HILFR10 / HILFR10F	2
15mm Strut Trim Packer	(Nitro Gas / Foam Cell)	HILFR15 / HILFR15F	2

• ONLY Compatible with Ironman 4x4 Struts (except Pro), lift height subject to 1:2 motion ratio. Unnecessary fitment may lift vehicle too high

SPACER KIT

Sway Bar Spacer	1198K	1
-----------------	-------	---

REAR SUSPENSION**SHOCK ABSORBER**

Nitro Gas			12682GRC	2
Foam Cell			24682FEC	2
Foam Cell Pro			45682FEC	2

COIL SPRINGS**Estimated Lift****Additional Load**

	Estimated Lift	Additional Load		
Performance SWB	45mm	0 - 300kg	TOY056A	1
Performance LWB	45mm	0 - 300kg	TOY056B	1
Constant Load	45mm	300kg - GVM	TOY056C	1

COIL SPACER

Polyurethane 20mm	LCPR20	2
Polyurethane 25mm	LCPR25	2

SWAY BAR LINK

Extended Sway Bar Link	SBEXT006	2
------------------------	----------	---

SUSPENSION KIT

Performance SWB Petrol w/ Gas Shocks	TOY055AKG
Performance SWB Petrol w/ Foam Cell	TOY055AKF
Performance SWB Petrol w/ Foam Cell Pro	TOY055AKP
Performance SWB Diesel w/ Gas Shocks	TOY055AKG1
Performance SWB Diesel w/ Foam Cell	TOY055AKF1
Performance SWB Diesel w/ Foam Cell Pro	TOY055AKP1
Performance LWB Petrol w/ Gas Shocks	TOY055BKG
Performance LWB Petrol w/ Foam Cell	TOY055BKF
Performance LWB Petrol w/ Foam Cell Pro	TOY055BKP
Performance LWB Diesel w/ Gas Shocks	TOY055BKG1
Performance LWB Diesel w/ Foam Cell	TOY055BKF1
Performance LWB Diesel w/ Foam Cell Pro	TOY055BKP1
Constant Load LWB Petrol w/ Gas Shocks	TOY055CKG
Constant Load LWB Petrol w/ Foam Cell	TOY055CKF
Constant Load LWB Petrol w/ Foam Cell Pro	TOY055CKP
Constant Load LWB Diesel w/ Gas Shocks	TOY055CKG1
Constant Load LWB Diesel w/ Foam Cell	TOY055CKF1
Constant Load LWB Diesel w/ Foam Cell Pro	TOY055CKP1

SUSPENSION KIT CONTENTS

Shock Absorbers	Coil Springs
Strut Shock Absorbers	



Product

Part No.

Qty Req

FRONT SUSPENSION

SHOCK ABSORBER

Nitro Gas Strut			12750GR	2
Foam Cell Strut			24750FE	2
Foam Cell Pro Strut			45750FE	2

• Height adjustable with Ironman 4x4 Strut Trim Packers

COIL SPRINGS

Estimated Lift

Additional Load

Performance Petrol	45mm	0 - 50kg	TOY065B	1
Constant Load or Diesel	45mm	50 - 110kg	TOY065C	1

TRIM PACKERS

5mm Strut Trim Packer	(Nitro Gas / Foam Cell)	HILFR05 / HILFR05F	2
10mm Strut Trim Packer	(Nitro Gas / Foam Cell)	HILFR10 / HILFR10F	2
15mm Strut Trim Packer	(Nitro Gas / Foam Cell)	HILFR15 / HILFR15F	2

• ONLY Compatible with Ironman 4x4 Struts (except Pro), lift height subject to 1:2 motion ratio. Unnecessary fitment may lift vehicle too high

SPACER KIT

Sway Bar Spacer	1198K	1
-----------------	--------------	---

REAR SUSPENSION

SHOCK ABSORBER

Nitro Gas		12682GRC	2
Foam Cell		24682FEC	2
Foam Cell Pro		45682FEC	2

COIL SPRINGS

Estimated Lift

Additional Load

Performance SWB	45mm	0 - 300kg	TOY056A	1
Performance LWB	45mm	0 - 300kg	TOY056B	1
Constant Load	45mm	300kg - GVM	TOY056C	1

COIL SPACER

Polyurethane 20mm	LCPR20	2
Polyurethane 25mm	LCPR25	2

SWAY BAR LINK

Extended Sway Bar Link	SBEXT006	2
------------------------	-----------------	---

SUSPENSION KIT

Performance SWB Petrol w/ Gas Shocks	TOY065AKG
Performance SWB Petrol w/ Foam Cell	TOY065AKF
Performance SWB Petrol w/ Foam Cell Pro	TOY065AKP
Performance SWB Diesel w/ Gas Shocks	TOY065AKG1
Performance SWB Diesel w/ Foam Cell	TOY065AKF1
Performance SWB Diesel w/ Foam Cell Pro	TOY065AKP1
Performance LWB Petrol w/ Gas Shocks	TOY065BKG
Performance LWB Petrol w/ Foam Cell	TOY065BKF
Performance LWB Petrol w/ Foam Cell Pro	TOY065BKP
Performance LWB Diesel w/ Gas Shocks	TOY065BKG1
Performance LWB Diesel w/ Foam Cell	TOY065BKF1
Performance LWB Diesel w/ Foam Cell Pro	TOY065BKP1
Constant Load LWB Petrol w/ Gas Shocks	TOY065CKG
Constant Load LWB Petrol w/ Foam Cell	TOY065CKF
Constant Load LWB Petrol w/ Foam Cell Pro	TOY065CKP
Constant Load LWB Diesel w/ Gas Shocks	TOY065CKG1
Constant Load LWB Diesel w/ Foam Cell	TOY065CKF1
Constant Load LWB Diesel w/ Foam Cell Pro	TOY065CKP1

SUSPENSION KIT CONTENTS

Shock Absorbers	Coil Springs
Strut Shock Absorbers	



Product

Part No.

Qty Req

FRONT SUSPENSION**SHOCK ABSORBER**

Nitro Gas Strut			12710GR	2
Foam Cell Strut			24710FE	2
Foam Cell Pro Strut			45710FE	2

• Height adjustable with Ironman 4x4 Strut Trim Packers

COIL SPRINGS

	Estimated Lift	Additional Load		
Comfort	30mm	0 - 50kg	TOY055A	1
Performance	45mm	0 - 50kg	TOY055B	1
Constant Load	45mm	50 - 110kg	TOY055C	1

TRIM PACKERS

5mm Strut Trim Packer	(Nitro Gas / Foam Cell)	HILFR05 / HILFR05F	2
10mm Strut Trim Packer	(Nitro Gas / Foam Cell)	HILFR10 / HILFR10F	2
15mm Strut Trim Packer	(Nitro Gas / Foam Cell)	HILFR15 / HILFR15F	2

• ONLY Compatible with Ironman 4x4 Struts (except Pro), lift height subject to 1:2 motion ratio. Unnecessary fitment may lift vehicle too high

SPACER KIT

Sway Bar Spacer	1198K	1
-----------------	--------------	---

REAR SUSPENSION**SHOCK ABSORBER**

Nitro Gas	12682GRC	2
Foam Cell	24682FEC	2
Foam Cell Pro	45682FEC	2

COIL SPRINGS

	Estimated Lift	Additional Load		
Comfort	40mm	0 - 300kg	TOY056A	1
Performance	50mm	0 - 300kg	TOY056B	1
Constant Load	50mm	300kg - GVM	TOY056C	1

COIL SPACER

Polyurethane 20mm	LCPR20	2
Polyurethane 25mm	LCPR25	2

SWAY BAR LINK

Extended Sway Bar Link	SBEXT006	2
------------------------	-----------------	---

SUSPENSION KIT

Comfort w/ Gas Shocks	TOY055AKG
Comfort w/ Foam Cell	TOY055AKF
Comfort w/ Foam Cell Pro	TOY055AKP
Performance w/ Gas Shocks	TOY055BKG
Performance w/ Foam Cell	TOY055BKF
Performance w/ Foam Cell Pro	TOY055BKP
Constant Load w/ Gas Shocks	TOY055CKG
Constant Load w/ Foam Cell	TOY055CKF
Constant Load w/ Foam Cell Pro	TOY055CKP

SUSPENSION KIT CONTENTS

Shock Absorbers	Coil Springs
Strut Shock Absorbers	



Product	Part No.	Qty Req
---------	----------	---------

FRONT SUSPENSION

SHOCK ABSORBER

Nitro Gas Strut	12710GR	2
Foam Cell Strut	24710FE	2
Foam Cell Pro Strut	45710FE	2

• Height adjustable with Ironman 4x4 Strut Trim Packers

COIL SPRINGS **Estimated Lift** **Additional Load**

Standard Height	0mm	0 - 50kg	TOY038B	1
Performance	45mm	0 - 50kg	TOY055A	1
Constant Load	45mm	50 - 110kg	TOY055B	1

TRIM PACKERS

5mm Strut Trim Packer	(Nitro Gas / Foam Cell)	HILFR05 / HILFR05F	2
10mm Strut Trim Packer	(Nitro Gas / Foam Cell)	HILFR10 / HILFR10F	2
15mm Strut Trim Packer	(Nitro Gas / Foam Cell)	HILFR15 / HILFR15F	2

• ONLY Compatible with Ironman 4x4 Struts (except Pro), lift height subject to 1:2 motion ratio. Unnecessary fitment may lift vehicle too high

SPACER KIT

Sway Bar Spacer	1198K	1
-----------------	--------------	---

REAR SUSPENSION

SHOCK ABSORBER

Nitro Gas Comfort	12743GRC	2
Nitro Gas	12743GR	2
Foam Cell Comfort	24743FEC	2
Foam Cell	24743FE	2
Foam Cell Pro Comfort	45743FEC	2
Foam Cell Pro	45743FE	2

COIL SPRINGS **Estimated Lift** **Additional Load**

Standard Height	0mm	0 - 200kg	TOY017S	1
Comfort	40mm	0 - 200kg	TOY017A	1
Performance	45mm	0 - 300kg	TOY017B	1

SUSPENSION KIT

Standard Height w/ Gas Shocks	TOY017SKG
Standard Height w/ Foam Cell	TOY017SKF
Standard Height w/ Foam Cell Pro	TOY017SKP
Comfort w/ Gas Shocks	TOY017AKG
Comfort w/ Foam Cell	TOY017AKF
Comfort w/ Foam Cell Pro	TOY017AKP
Performance w/ Gas Shocks	TOY017BKG
Performance w/ Foam Cell	TOY017BKF
Performance w/ Foam Cell Pro	TOY017BKP

• Specify front coil springs when ordering

SUSPENSION KIT CONTENTS

Shock Absorbers	Coil Springs
Strut Shock Absorbers	



Product

Part No.

Qty Req

FRONT SUSPENSION**SHOCK ABSORBER**

Nitro Gas Strut			12710GR	2
Foam Cell Strut			24710FE	2
Foam Cell Pro Strut			45710FE	2

• Height adjustable with Ironman 4x4 Strut Trim Packers

COIL SPRINGS

	Estimated Lift	Additional Load		
Performance	45mm	0 - 50kg	TOY065B	1
Constant Load	45mm	50 - 110kg	TOY065C	1

TRIM PACKERS

5mm Strut Trim Packer	(Nitro Gas / Foam Cell)	HILFR05 / HILFR05F	2
10mm Strut Trim Packer	(Nitro Gas / Foam Cell)	HILFR10 / HILFR10F	2
15mm Strut Trim Packer	(Nitro Gas / Foam Cell)	HILFR15 / HILFR15F	2

• ONLY Compatible with Ironman 4x4 Struts (except Pro), lift height subject to 1:2 motion ratio. Unnecessary fitment may lift vehicle too high

REAR SUSPENSION**SHOCK ABSORBER**

Nitro Gas			12744GR	2
Foam Cell			24744FE	2
Foam Cell Pro			45744FE	2

LEAF SPRINGS

	Estimated Lift	Additional Load		
Performance Drivers Side	50mm	0 - 200kg	TOY066BD/S	1
Performance Near Side	50mm	0 - 200kg	TOY066BN/S	1

U-BOLTS

U-Bolt Kit			437UBK	2
------------	--	--	---------------	---

POLYURETHANE SPRING BUSHES

Bush Kit			1191UK	1
----------	--	--	---------------	---

SPACER KIT

Centre Bearing Spacer Kit			1192K	1
---------------------------	--	--	--------------	---

LOAD PLUS

Load Plus Helper Springs			LP3	1
--------------------------	--	--	------------	---

SUSPENSION KIT

Performance w/ Gas Shocks	TOY066BKG
Performance w/ Foam Cell	TOY066BKF
Performance w/ Foam Cell Pro	TOY066BKP

• Specify front coil springs when ordering

SUSPENSION KIT CONTENTS

Shock Absorbers	Leaf Springs	Centre Bearing Spacer Kit
Strut Shock Absorbers	U-Bolts	
Coil Springs	Polyurethane Spring Bushes	



Product	Part No.	Qty Req
---------	----------	---------

FRONT SUSPENSION

SHOCK ABSORBER

Foam Cell Strut	24780FE	2
Foam Cell Pro Strut	45780FE	2

- Height adjustable with Ironman 4x4 Strut Trim Packers
- Foam Cell Pro - Must use TOY063B or TOY063C Front Coil Springs

COIL SPRINGS **Estimated Lift** **Additional Load**

Performance	60mm	0 - 50kg	TOY070B	1
Constant Load	60mm	50 - 110kg	TOY070C	1

- Not compatible with Foam Cell Pro

TRIM PACKERS

5mm Foam Cell Strut Trim Packer	HILFR05F	2
10mm Foam Cell Strut Trim Packer	HILFR10F	2
15mm Foam Cell Strut Trim Packer	HILFR15F	2

- ONLY Compatible with Ironman 4x4 Struts (except Pro), lift height subject to 1:2 motion ratio. Unnecessary fitment may lift vehicle too high

REAR SUSPENSION

SHOCK ABSORBER

Foam Cell	24781FE	2
Foam Cell Pro	45781FE	2

LEAF SPRINGS **Estimated Lift** **Additional Load**

Performance	60mm	0 - 200kg	TOY071B	2
-------------	------	-----------	----------------	---

U-BOLTS

U-Bolt Kit	678UBK	2
------------	---------------	---

POLYURETHANE SPRING BUSHES

Bush Kit	1196UK	1
----------	---------------	---

SPACER KIT

Brake Hose Relocation Kit	1197K	1
---------------------------	--------------	---

GREASABLE SHACKLES AND PINS

Greasable Shackle	1150	2
-------------------	-------------	---

LOAD PLUS

Load Plus Helper Springs	LP4	1
--------------------------	------------	---

SUSPENSION KIT

Performance w/ Foam Cell	TOY070BKF
Performance w/ Foam Cell Pro	TOY070BKP

- Specify front coil springs when ordering

SUSPENSION KIT CONTENTS

Shock Absorbers	Leaf Springs	Brake Hose Relocation Kit
Strut Shock Absorbers	U-Bolts	
Coil Springs	Polyurethane Spring Bushes	

T4

1997 - 6/2014



Product	Part No.	Qty Req
---------	----------	---------

FRONT SUSPENSION**SHOCK ABSORBER**

Nitro Gas	12755GR	2
-----------	---------	---

COIL SPRINGS**Estimated Lift****Additional Load**

Performance	50mm	0 - 50kg	TROL001B	1
-------------	------	----------	----------	---

REAR SUSPENSION**SHOCK ABSORBER**

Nitro Gas	12755GR	2
-----------	---------	---

COIL SPRINGS**Estimated Lift****Additional Load**

Performance	50mm	0 - 200kg	TROL002B	1
-------------	------	-----------	----------	---

SUSPENSION KIT

Performance w/ Gas Shocks	TROL001BKG
---------------------------	------------

SUSPENSION KIT CONTENTS

Shock Absorbers	Coil Springs
-----------------	--------------



T4
7/2014+

TROLLER

Product **Part No.** **Qty Req**

FRONT SUSPENSION

SHOCK ABSORBER

Nitro Gas **12765GR** 2

COIL SPRINGS

Estimated Lift **Additional Load**

Performance 45mm 0 - 50kg **TROL003B** 1

REAR SUSPENSION

SHOCK ABSORBER

Nitro Gas **12765GR** 2

COIL SPRINGS

Estimated Lift **Additional Load**

Performance 45mm 0 - 200kg **TROL004B** 1

SUSPENSION KIT

Performance w/ Gas Shocks **TROL003BKG**

SUSPENSION KIT CONTENTS

Shock Absorbers Coil Springs



Product	Part No.	Qty Req
---------	----------	---------

FRONT SUSPENSION

SHOCK ABSORBER

Nitro Gas	12652GR	2
Foam Cell	24652FE	2

COIL SPRINGS **Estimated Lift** **Additional Load**

Performance	45mm	0 - 80kg	IMAZ001B	1
-------------	------	----------	-----------------	---

REAR SUSPENSION

SHOCK ABSORBER

Nitro Gas	12698GR	2
Foam Cell	24698FE	2

LEAF SPRINGS **Estimated Lift** **Additional Load**

Performance	45mm	0 - 300kg	IMAZ002B	1
-------------	------	-----------	-----------------	---

U-BOLTS

U-Bolt Kit	678UBK	2
------------	---------------	---

POLYURETHANE SPRING BUSHES

Bush Kit	1188UK	1
----------	---------------	---

GREASABLE SHACKLES AND PINS

Greasable Shackle	1189	2
-------------------	-------------	---

SUSPENSION KIT

Performance w/ Gas Shocks	IMAZ001BKG
Performance w/ Foam Cell	IMAZ001BKF

SUSPENSION KIT CONTENTS

Shock Absorbers	U-Bolts
Coil Springs	Polyurethane Spring Bushes
Leaf Springs	Shackles



Product **Part No.** **Qty Req**

FRONT SUSPENSION

SHOCK ABSORBER

Nitro Gas			12637GR	2
Foam Cell			24637FE	2

COIL SPRINGS **Estimated Lift** **Additional Load**

Performance	45mm	0 - 80kg	IMAZ001B	1
-------------	------	----------	-----------------	---

REAR SUSPENSION

SHOCK ABSORBER

Nitro Gas			12698GR	2
Foam Cell			24698FE	2

LEAF SPRINGS **Estimated Lift** **Additional Load**

Performance	45mm	0 - 300kg	IMAZ002B	1
-------------	------	-----------	-----------------	---

U-BOLTS

U-Bolt Kit			678UBK	2
------------	--	--	---------------	---

POLYURETHANE SPRING BUSHES

Bush Kit			1188UK	1
----------	--	--	---------------	---

GREASABLE SHACKLES AND PINS

Greasable Shackle			1189	2
-------------------	--	--	-------------	---

SUSPENSION KIT

Performance w/ Gas Shocks	IMAZ001BKG1
Performance w/ Foam Cell	IMAZ001BKF1

SUSPENSION KIT CONTENTS

Shock Absorbers	U-Bolts
Coil Springs	Polyurethane Spring Bushes
Leaf Springs	Shackles

AMAROK

2010+

**Product****Part No.****Qty Req****FRONT SUSPENSION****SHOCK ABSORBER**

Nitro Gas Strut	12725GR	2
-----------------	----------------	---

- Height adjustable with Ironman 4x4 Strut Trim Packers

COIL SPRINGS**Estimated Lift****Additional Load**

	Estimated Lift	Additional Load	Part No.	Qty Req
Performance	30mm	0 - 50kg	VOLKS001B	1
Constant Load	30mm	50 - 110kg	VOLKS001C	1

TRIM PACKERS

5mm Nitro Gas Strut Trim Packer	HILFR05	2
---------------------------------	----------------	---

10mm Nitro Gas Strut Trim Packer	HILFR10	2
----------------------------------	----------------	---

15mm Nitro Gas Strut Trim Packer	HILFR15	2
----------------------------------	----------------	---

- ONLY Compatible with Ironman 4x4 Struts, lift height subject to 1:2 motion ratio. Unnecessary fitment may lift vehicle too high

REAR SUSPENSION**SHOCK ABSORBER**

Nitro Gas	12726GR	2
-----------	----------------	---

LEAF SPRINGS**Estimated Lift****Additional Load**

	Estimated Lift	Additional Load	Part No.	Qty Req
Performance	35mm	0 - 300kg	VOLKS002B	2
Constant Load	35mm	200 - 400kg	VOLKS002C	2

U-BOLTS

U-Bolt Kit	415UBK	2
------------	---------------	---

POLYURETHANE SPRING BUSHES

Bush Kit	1190UK	1
----------	---------------	---

LOAD PLUS

Load Plus Helper Springs	LP4	1
--------------------------	------------	---

SUSPENSION KIT

Performance w/ Gas Shocks	VOLKS001BKG
---------------------------	--------------------

Constant Load w/ Gas Shocks	VOLKS001CKG
-----------------------------	--------------------

- Specify front coil springs when ordering

SUSPENSION KIT CONTENTS

Shock Absorbers	Leaf Springs
Strut Shock Absorbers	U-Bolts
Coil Springs	Polyurethane Spring Bushes



Part Number	Material	Free Height	End I/D	Spring Rate Nm	Spring Rate lbf/in
FOR001A	18.5	355	80	152	869
FOR001B	18.5	360	80	173	989
FOR001C	18.5	367	80	173	989
FOR001S	18	350	80	158	903
HOLD008B	16.4	425	104	43	246
HOLD008C	17	420	106	48	274
HOLD020A	16.5	382	66/76	106	606
HOLD020B	17	375	66/76	117	669
HOLD020C	18	368	66/76	147	840
HOLD020S	17	362	66/76	117	669
HOLD022B	16	410	65	120	686
HOND001B	13	360	61/70	52	297
HOND002B	13.5	420	72/79	40	229
HYUND003B	17	407	148	33	189
IMAZ001B	16	395	102	49	280
JEEP003B	15	432/436	65/100	37	211
JEEP006B	14	380/375	62/102	32	183
JEEP007B	15	440/435	66/100	36	206
JEEP008B	16	345/335	72	35	200
JEEP012B	15	420/410	98	39	223
JEEP013B	16	350/340	75	43	246
JEEP014B	16.5	375	82	78	446
JEEP014C	16.5	382	82	78	446
JEEP015B	17	323	85/115	38	217
JEEP016B	15.5	465	70/102	38	217
JEEP017B	15	460/450	73/103	32	183
JEEP017C	15.5	460/450	73/103	36	206
JEEP018A	15.5	388	52/103	40	229
JEEP018B	16	388	52/103	45	257
JEEP019B	15	500	73/103	32	183
JEEP020B	16	417	56/103	43	246
LADA001B	16	285	92	89	509
LADA002B	14	435	100	32	183
LAND005B	17	400	118	41	234
LAND006B	20	405	134	82	469
LAND006C	21	440	134	82	469

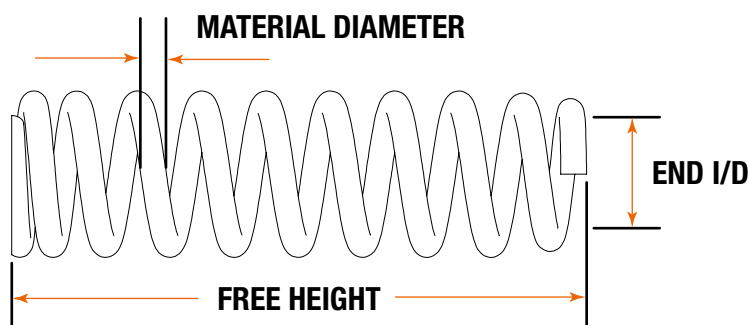

All measurements are in mm unless otherwise stated



Part Number	Material	Free Height	End I/D	Spring Rate Nm	Spring Rate lbf/in
LAND007B	16	390/382	118	41	234
LAND009B	16	405/395	117	36	206
LAND011B	17	425/420	117	46-53	262-302
LAND011C	18	425/420	118	56-64	319-365
LAND014B	15	410/390	117	30	171
LAND019B	17	415	90	83	474
LAND019C	17	427	90	83	474
LAND020B	21	402	80/100	82	469
LAND020C	21	415	80/100	88	503
MAH003B	15	405	97	46	263
MERC015B	14.5	495/485	110	28	160
MERC016B	18	445/433	140	28-44	159-251
MIT020B	17	405/400	145	34	194
MIT020C	18	420	148	39	223
MIT022B	16	410/400	145	27	154
MIT025B	17	390	124	45	257
MIT034B	16	367	140	35	200
MIT035B	14	315/305	120	40	229
MIT038B	19	323	72/93	141	806
MIT038C	19	336	72/93	141	806
MIT039A	21	330/320	113	137-166	782-947
MIT039B	21	350/340	113	137-166	782-948
MIT039C	22	335	113	162-196	925-1119
MIT040A	17	328	64/93	105	600
MIT040B	18	323	64/93	118	674
MIT040C	19	315	64/93	147	840
MIT040S	18	310	64/93	118	674
MIT042A	17	370	145	32	183
MIT042B	17	388	145	32	183
MIT042C	18	360	146	50	286
MIT042S	17	355	145	32	183
NISS007B	16	415/400	89/122	36.9	211
NISS008B	17	490/480	139	33	189
NISS009B	17	410/387	87/122	46	263
NISS009C	18	415/398	89/122	58	331
NISS010B	19	468/448	139	50	286
NISS010C	19	488/470	139	46	263
NISS018B	14	427	106	34	194
NISS020B	19	490/480	139	50	286
NISS020C	20	475/458	139	60	343
NISS020D	22	475/453	139	85	486
NISS024B	17	425/410	87/122	46	263
NISS026B	18	484/469	87/122	48	274
NISS027B	20	535/521	139	52	297

All measurements are in mm unless otherwise stated



Part Number	Material	Free Height	End I/D	Spring Rate Nm	Spring Rate lbf/in
NISS034B	16	400	119/146	28	160
NISS035B	15	370	126	29	166
NISS038B	15	325	134/146	36	206
NISS039B	15	325	114/146	36	206
NISS040B	17	370	81	97	554
NISS040C	17	380	81	97	554
NISS040D	17.5	380	81	108	617
NISS042B	19	443	119	75	429
NISS042C	20	443	119	90	514
NISS043B	19	525/510	87/122	48	274
NISS044B	21	590/575	139	49	280
NISS045A	20	373	101	135	771
NISS045B	20	385	101	135	771
NISS045C	20	390	101	135	771
NISS046A	21	515	119	90	514
NISS046B	21	522	119	90	514
NISS046C	21.5	528	119	99	566
REN001B	13.5	400	99/117	30	171
REN002B	14	375	99/17	35	200
SSANG002B	16	410	116	41	234
SUB001B	15	350	123/144	34	194
SUB002B	15.5	345/340	128	38	217
SUB003B	15.5	355	123	29	166
SUB004B	15	365	99	39	223
SUZ003B	16	280	70/80	103	589
SUZ004B	12	345	70/82	25	143
SUZ005B	16	290	70/80	103	589
SUZ006B	13	340	72/82	33	189
SUZ008B	11	325/320	70/82	27	154
SUZ009B	12	372	75/82	29	166
SUZ010B	11.5	348/328	75/84	27	154
SUZ011B	11.5	335	75/84	27	154
SUZ013B	12.5	345	62/80	33	189
SUZ015B	16	320	72/82	86	491
SUZ016B	12.5	360	62/80	33	189
SUZ017B	16	340	72/82	86	491

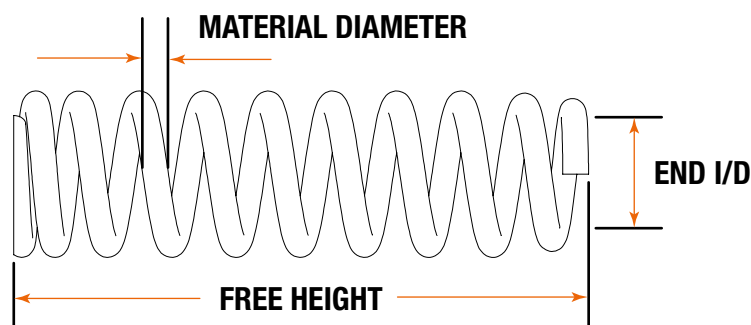

All measurements are in mm unless otherwise stated



Part Number	Material	Free Height	End I/D	Spring Rate Nm	Spring Rate lbf/in
SUZ018B	14	360	63/96	35	200
SUZ019B	16	385	125	42	240
SUZ019C	16	395	125	42	240
SUZ020A	16.5	363	72	77	440
SUZ020B	17	366	72	88	503
TOY012C	19	515/520	84/119	49	280
TOY013B	18	485/495	108/140	40	229
TOY013C	20	490/497	108/140	57	326
TOY017A	16	470	90	54-60	308-342
TOY017B	16	463	90	59	337
TOY017S	16	455	90	54-60	308-342
TOY018B	14	395/380	86/100	35	200
TOY019B	16	420/405	86/125	38	217
TOY023B	16	390/385	103/133	31	177
TOY023C	17	375/370	103/134	39	223
TOY024B	17	480/485	81/116	41	234
TOY024C	17	500/505	82/117	41	234
TOY025B	18	473/483	108/139	40	229
TOY025C	19	460/475	107/139	48	274
TOY025D	22	470/478	108/140	70	400
TOY038B	16	348/357	67/76	108	617
TOY038C	17	357	67/76	133	760
TOY039A	15	398	74/114	31-36	177-205
TOY039B	15	410	74/114	31-36	177-206
TOY039C	17	385	74/114	45-51	256-291
TOY046A	16	470	86/100	50	286
TOY046B	17	458	86/100	59	337
TOY046C	18	450	85/100	72	411
TOY048B	14	438	100	34	194
TOY048C	14.5	428	100	39	223
TOY049B	17	450	87/125	34	194
TOY049C	18	440	87/125	44	251
TOY055A	16.5	380	66/76	106	606
TOY055B	17	380	66/76	117	669
TOY055C	18	373	66/76	143	817
TOY056A	16.5	400	83/130	41	234
TOY056B	17	395	83/130	49	280
TOY056C	18	392	85/129	62	354
TOY060B	20	614/622	84/119	44	251
TOY061B	21	627/637	108/140	43	246
TOY063A	19	450/440	73/89	47	269
TOY063B	19	465/455	73/89	102	583
TOY063C	19	470/460	73/89	102	583
TOY064A	19	440/425	108/144	47	269

All measurements are in mm unless otherwise stated



COIL SPRINGS & TRIM PACKERS

SPECIFICATIONS

Part Number	Material	Free Height	End I/D	Spring Rate Nm	Spring Rate lbf/in
TOY064B	19	470/455	108/144	47	269
TOY064C	21	465/455	108/144	65	371
TOY064EA	20	475/465	108/144	50	286
TOY065B	18.5	370	65/76	151	863
TOY065C	19	370	65/76	168	960
TOY067B	18	300	82/122	90	514
TOY070B	20	412	65/88	132	754
TOY070C	20	422	65/88	132	754
TROL001B	15.5	390	94	58	331
TROL002B	15.5	430	102	39	223
VOLKS001B	17.5	330	65/90	120	686
VOLKS001C	18	330	65/90	137	783

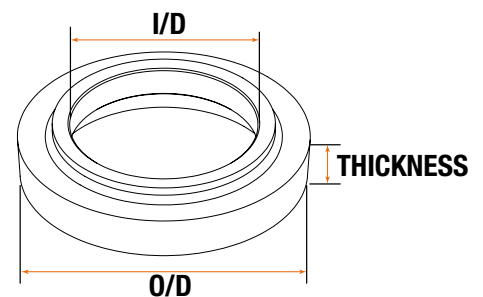
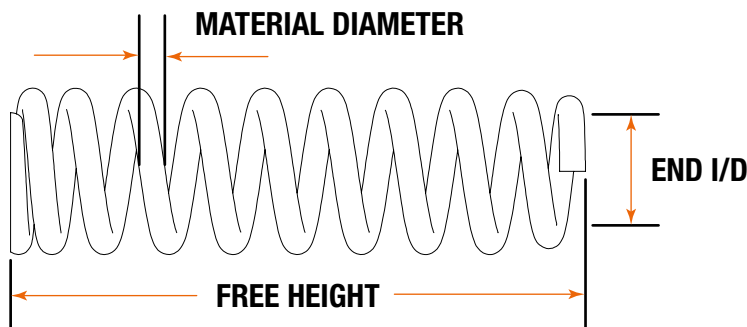

TRIM PACKERS

Part Number	O/D	I/D	Thickness	Material
HILFR05	63	54.5	5	Steel
HILFR05F	63	60.5	5	Steel
HILFR10	63	54.5	10	Steel
HILFR10F	63	60.5	10	Steel
HILFR15	63	54.5	15	Steel
HILFR15F	63	60.5	15	Steel
LC70F30	138	86	30	Polyurethane
LCF20	160	114.5	20	Polyurethane
LCF30	160	114.5	30	Polyurethane
LCPR20	168	108	20	Polyurethane
LCPR25	168	108	25	Polyurethane
LCR15	187	133.5	15	Polyurethane
PATF15	172	116	15	Polyurethane
PATF30	172	116	30	Polyurethane
PATR15	180	120	15	Polyurethane
PATR30	180	120	30	Polyurethane

All measurements are in mm unless otherwise stated



Part Number	Length A	Length B	Camber	Leaves	Width	Eye A	Eye B
FOR002A	590	730	130	5+2	60	55	32
FOR002B	590	730	140	5+2	60	55	32
FOR002C	590	730	155	6+2	60	55	32
HOLD004A	550	650	250/240	5+1	60	40	30
HOLD004B	550	650	250/240	5+1	60	40	30
HOLD004C	550	650	250/240	6+1	60	40	30
HOLD006A	603	602	220	4+1	60	40	30
HOLD006B	603	602	215	5+1	60	40	30
HOLD006C	603	602	215	6+1	60	40	30
HOLD021A	615	755	155	5+2	60	40	30
HOLD021B	615	755	165	5+2	60	40	30
HOLD021C	615	755	165	6+2	60	40	30
IMAZ002B	650	700	165	8	60	42	42
JEEP004B	585	725	195/175	5+2	63	64.5	44.3
MAH002B	612	610	185	5+2	70	35	35
MAZDA006A	530	670	165	5+1	60	32	32
MAZDA006B	530	675	150	6+2	60	32	32
MAZDA006C	530	675	165	6+2	60	32	32
MAZDA006D	530	675	150	7+2	60	32	32
MAZDA041A	590	730	140	4+2	60	40	32
MAZDA041B	590	730	140	4+2	60	40	32
MAZDA041C	590	720	140	5+2	60	40	32
MAZDA041D	590	720	130	6+2	60	40	32
MITSO18A	520	685	200	4+1	70	32	28
MITSO18B	515	685	195	4+1	70	32	28
MITSO18C	518	688	190	5+1	70	32	28
MITSO41A	515	685	140	4+1	70	32	28
MITSO41B	515	685	145	4+1	70	32	28
MITSO41C	515	685	155	5+1	70	32	28
NISS003B	560	550	185/170	6	60	22	33
NISS004B	604	838	250/235	8	60	33	33
NISS005B	560	550	185/170	6	60	40	33
NISS011C	550	550	180/170	7	70	40	35
NISS012C	595	825	217/200	7+2	70	35	35
NISS012D	600	830	240/225	7+3	70	35	35
NISS014A	565	635	145/135	4+2	60	40	33
NISS014B	565	635	130/120	4+1	60	40	33
NISS014C	565	635	130/120	5+1	60	40	33
NISS021B	650	580	200	8	60	33	40
NISS041B	670	735	195	5+1	60	40	33
NISS041C	670	730	190	6+1	60	40	33
NISS041D	670	730	180	7+2	60	40	33
NISS047B	635	715	195	7+1	60	40	33
NISS049B	700	650	230	5+1	60	40	33

All measurements are in mm unless otherwise stated



Part Number	Length A	Length B	Camber	Leaves	Width	Eye A	Eye B
NISS057B	670	605	175	5+2	60	40	33
NISS057C	670	605	175	6+2	60	40	33
SUZ001B	480	470	120/110	5	50	30	40
SUZ002B	510	520	175/155	4+1	50	40	30
TOY001B	505	610	160	7	70	25	25
TOY002B	505	620	180	7	70	25	25
TOY003C	660	660	230	7+3	70	30	30
TOY004B	505	610	160	7	70	35	35
TOY004C	502	603	155	8	70	35	35
TOY005C	655	675	230	7+3	70	35	35
TOY006B	550	550	150	7	70	35	35
TOY006C	550	550	175	8	70	35	35
TOY006D	550	550	175	9	70	35	35
TOY007A	565	655	230/220	7	70	35	35
TOY007B	565	645	220/205	6+1	70	35	35
TOY007C	565	655	230/220	7+1	70	35	35
TOY008B	550	590	180	7	70	35	35
TOY008C	550	590	180	8	70	35	35
TOY009B	600	730	210	6+2	70	40	40
TOY009C	603	720	210	7+2	70	40	40
TOY009D	600	720	215	8+2	70	40	40
TOY009E	605	720	220	9+2	70	40	40
TOY010B	575	575	135/115	5	60	30	30
TOY010C	575	575	130/110	6	60	30	30
TOY011B	530	670	200	4+2	60	30	30
TOY011C	530	67	210	5+2	60	30	30
TOY027A	560	740	200	6+2	60	40	30
TOY027B	560	740	200	4+2	60	40	30

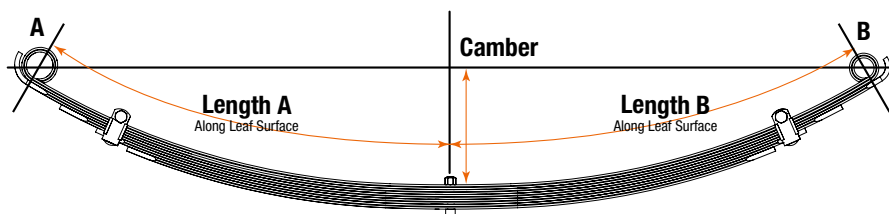

SINGLE STAGE SPRINGS

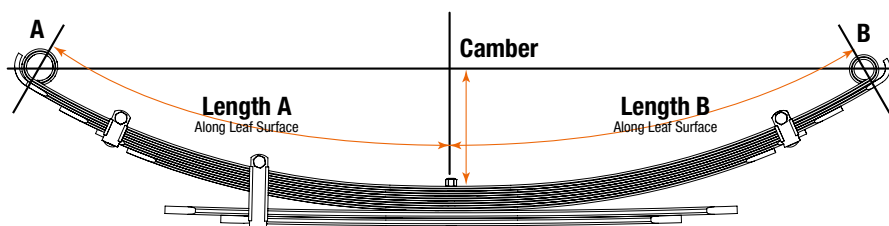

TWO STAGE SPRINGS

All measurements are in mm unless otherwise stated



Part Number	Length A	Length B	Camber	Leaves	Width	Eye A	Eye B
TOY027C	560	740	200	5+2	60	40	30
TOY034B	505	630	205	7	70	35	35
TOY047A	690	815	245	7+2	70	40	40
TOY047B	690	815	245	8+2	70	40	40
TOY047C	690	815	245	9+2	70	40	40
TOY047D	693	820	265	9+3	70	40	40
TOY047E	693	815	265	9+2	70	40	40
TOY057A	610	690	180	6+2	60	40	30
TOY057B	610	690	200	4+2	60	40	30
TOY057C	610	690	200	5+2	60	40	30
TOY057D	610	690	200	6+2	60	40	30
TOY062B	615	785	245	7+2	70	40	40
TOY062C	615	785	245	8+2	70	40	40
TOY066B	705	705	185/175	5+2	60	40	40
TOY068B	590	690	200	4+2	60	40	30
TOY071B	800	815	200	4+2	60	40	40
VOLKS002B	750	760	255	5+2	70	60	46
VOLKS002C	750	760	255	6+2	70	60	46

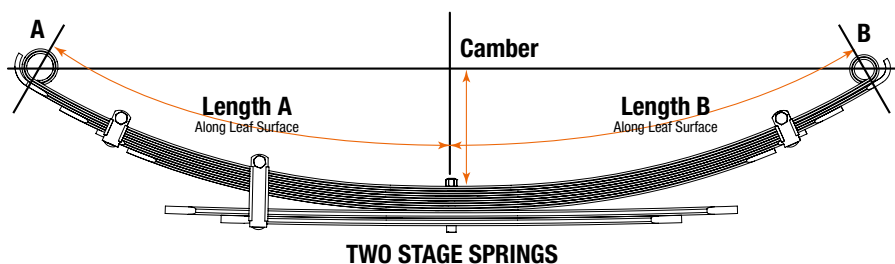
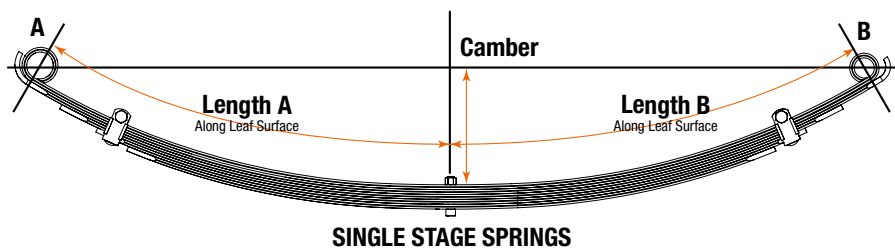

All measurements are in mm unless otherwise stated



Part Number	Length	Diameter	A End Spline Count	B End Spline Count
HOLD005A	1000	26	43	43
HOLD007	1000	26	47	47
HOLD009	1220	30	47	47
HOLD010	1144	30	47	47
HYUND004	1275	29.3	43	43
MAZDA005	924	26	40	40
MAZDA014	1025	27	40	40
MAH001	1063	28	43	43
MITS013	1278	26	39	40
MITS015C	1370	27.5	39	40
MITS019	1308	27.5	39	40
MITS031	1165	24	40	40
NISS013	1203	26	39	39
NISS017	1232	26	39	39
NISS025	894	26	39	39
NISS048	866	26	39	39
SSANG001	1040	26	40	40
TOY026	1063	26	43	40
TOY042	1212	26.5	40	40
TOY050	1160	32	46	46
TOY051	1210	32	46	46

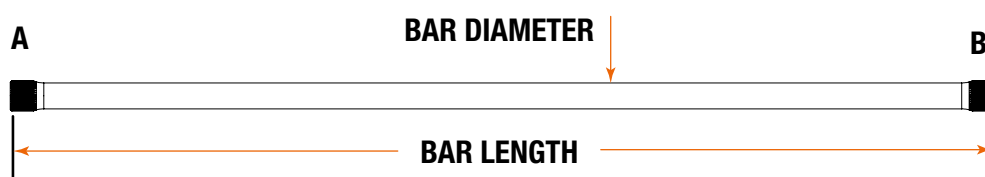

All measurements are in mm unless otherwise stated



Part Number	Extended (mm)	Compressed (mm)	Upper Mount Type	Upper Replacement	Lower Mount Type	Lower Replacement
12075GR	487	296	ST1	2244K	ST1	2244K
12076GR	583	347	B1	632RF	ST1	2244K
12080GR	552	332	ST38	656RK	ST38	656RK
12081GR	631	388	B2	635RK	B2	635RK
12082GR	342	227	ST1	2244K	CB7	CB7
12083GR	505	310	STEM 57 X M14	-	CLEVIS	-
12085GR	485	298	ST1	2244K	B1	632RF
12086GR	500	313	B1	632RF	B1	632RF
12087GR	350	230	ST1	2244K	ET17	ET17
12088GR	368	245	ST1	2244K	ET113	ET113
12089GR	510	320	ST1	2244K	ET83	-
12091GR	510	310	ST38	656RK	ST38	656RK
12094GR	655	402	B2	635RK	B2	635RK
12095GR	631	382	ET104	ET104	ET69	ET69
12635GR	485	307	B1	632RF	B1	632RF
12636GR	588	357	B1	632RF	B1	632RF
12637GR	577	348	ST1	2244K	B2	635RK
12639GR	484	298	ST1	2244K	ET17	ET17
12640GR	564	343	B2	635RK	ST38	656RK
12643GR	412	261	ST6	2244AK	ET17	ET17
12644GR	510	320	ET153	-	ET36	-
12645GR	531	333	B1	632RF	ET142	-
12646GR	495	310	ST1	2244K	ET113	ET113
12648GR	640	385	B2	635RK	ST1	2244K
12650GR	593	364	B2	635RK	B2	635RK
12652GR	540	333	B1	632RF	B1	632RF
12658GR	510	320	ST1	2244K	ET83	-
12661GR	535	329	ST1	2244K	B2	635RK
12665GR	565	345	ST1	2244AK	CB7	CB7
12666GR	560	340	CB20	CB20	B5	-
12667GR	381	245	ST1	2244K	ET17	ET17
12669GR	560	340	CB20	CB20	ET24	-
12670GR	562	343	B5	-	ET24	-
12671GR	627	372	ST1	2244K	B1	632RF
12682GR	618	373	ST38	656RK	B2	635RK
12682GRC	618	373	ST38-1	ST38-1	ET38	ET38
12683GR	615	365	ST38	656RK	ST38	656RK
12691GR	462	343	ST38	656RK	ET153	ET153
12696GR	570	347	ET161	-	ST1	2244K
12697GR	520	322	B2	635RK	ST1	2244K
12698GR	624	381	B1	632RF	B1	632RF
12710GR	540	408	STEM 95 X M12	ST710RK	ET153-1	ET153-1

All measurements are in mm unless otherwise stated



SHOCK ABSORBERS - NITRO GAS

SPECIFICATIONS

Part Number	Extended (mm)	Compressed (mm)	Upper Mount Type	Upper Replacement	Lower Mount Type	Lower Replacement
12711GR	317	205	STEM 68 X M10	-	-	-
12712GR	570	355	ET19	-	ET141	-
12712LGR	700	416	ET19	-	ET141	-
12713GR	470	325	STEM 86 X M10	-	ET158	ET158
12714GR	575	350	ST1	-	ET159	-
12715GR	423	305	STEM 71 X M10	-	ET158-1	ET158-1
12716GR	388	283	STEM 85 X M12	656R	ET153-2	ET153-2
12717GR	575	352	B1	632RF	ET34	ET34
12718GR	380	265	ET159	-	ET159	-
12720GR	600	435	STEM 69 X M14	ST720RK	ET113-1	ET113-1
12721GR	607	382	STEM 28 X M14	-	CLEVIS	-
12722GR	545	340	ET83	-	ET83	-
12725GR	615	460	STEM 56 X M12	-	FORK	-
12726GR	632	378	ET69	ET69	ET69	ET69
12727GR	512	378	STEM 65 x M12	ST727RK	ET154	ET154
12740GR	452	299	STEM 81 X M12	-	ET158-2	ET158-2
12742GR	564	356	ST42	-	ET160	ET160
12743GR	575	346	ST10	ST10RK	B2	635R
12744GR	609	361	ST10	ST10RK	ET17	ET17
12745GR	499	359	STEM 64 x M12	ST710RK	ET153	ET153
12746GR	605	360	ST1	2244K	ET17	ET17
12747GR	607	394	STEM 45 x M14	-	CLEVIS	-
12748GR	711	445	STEM 45 x M14	-	CLEVIS	-
12749GR	530	325	ET69	ET69	B1	632RF
12750GR	552	425	STEM 68 X M12	ST710RK	ET153-3	ET153-3
12751GR	575	325	ST38	656RK	ET69	632RF
12751LGR	650	382	ST38	656RK	ET69	632RF
12752GR	617	374	CB35	CB35	ET69	632RF
12752LGR	665	396	CB35	CB35	ET69	632RF
12755GR	625	381	ET113	-	ET113	-

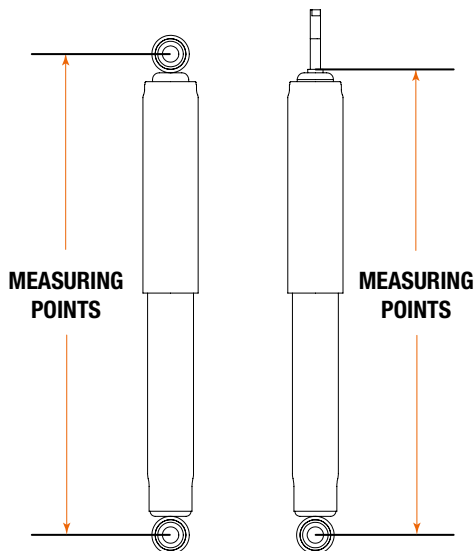

All measurements are in mm unless otherwise stated



Part Number	Extended (mm)	Compressed (mm)	Upper Mount Type	Upper Replacement	Lower Mount Type	Lower Replacement
12756GR	430	286	ET173	-	ET173	-
12757GR	650	390	CB34	-	ET34	-
12759GR	450	290	ST1	2244K	ET17	ET17
12760GR	500	310	ET17	ET17	ET17	ET17
12764GR	440	307	STEM 70 x M12	-	ET153	ET153
12774GR	550	330	ST6	2244AK	CB7	CB7
12775GR	575	350	ET61	-	ET65	-
12776GR	587	362	ET172	-	CB34	-
12777GR	587	362	ET172	-	ET172	-
12780GR	613	450	STEM 68 x M12	ST710RK	ET113-1	ET113-1
12781GR	650	384	ST38	ST21RK	ET38-2	ET38-2
12791GR	310	215	ST1	2244K	ET17	ET17
12795GR	441	290	ST21	ST21RK	ET153	-
12796GR	619	369	ST21	ST21RK	B2	635RK

All measurements are in mm unless otherwise stated



SHOCK ABSORBERS - FOAM CELL

SPECIFICATIONS

Part Number	Extended (mm)	Compressed (mm)	Upper Mount Type	Upper Replacement	Lower Mount Type	Lower Replacement
24080FE	552	332	ST38	656RK	ST38	656RK
24081FE	631	388	B2	635RK	B2	635RK
24082FE	342	227	ST1	2244K	CB7	CB7
24087FE	350	230	ST1	2244K	ET17	ET17
24088FE	368	245	ST1	2244K	ET113	2244K
24091FE	510	310	ST38	656RK	ST38	656RK
24091LFE	557	354	ST38	656RK	ST38	656RK
24091LFE1	597	353	ST38	656RK	ST38	656RK
24094FE	655	402	B2	635RK	B2	635RK
24094LFE	718	430	B2	635RK	B2	635RK
24094LFE1	760	450	B2	635RK	B2	635RK
24095FE	631	382	ET104	ET104	ET69	ET69
24635FE	485	307	B1	632RF	B1	632RF
24636FE	588	357	B1	632RF	B1	632RF
24637FE	577	348	ST1	2244K	B2	635RK
24639FE	484	298	ST1	2244K	ET17	ET17
24640FE	564	343	B2	635RK	ST38	656RK
24643FE	412	261	ST6	244AK	ET17	ET17
24644FE	510	320	ET153	-	ET36	-
24645FE	531	333	B1	632RF	ET142	-
24646FE	495	310	ST1	2244K	ET113	ET113
24648FE	640	385	B2	635RK	ST1	2244K
24650FE	593	364	B2	635RK	B2	635RK
24652FE	540	333	B1	632RF	B1	632RF
24661FE	535	329	ST1	2244K	B2	635RK
24665FE	565	345	ST1	2244K	CB7	CB7
24666FE	560	340	CB20	CB20	B5	-
24667FE	381	245	ST1	244AK	ET17	ET17
24682FE	618	373	ST38	656RK	B2	635RK
24682LFE	670	398	ST38	656RK	B2	635RK

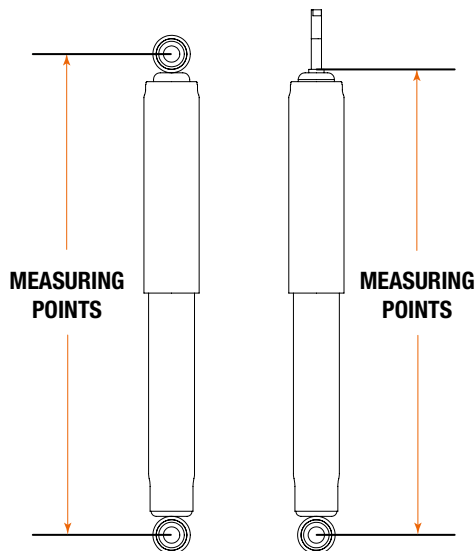

All measurements are in mm unless otherwise stated



Part Number	Extended (mm)	Compressed (mm)	Upper Mount Type	Upper Replacement	Lower Mount Type	Lower Replacement
24682LFE1	730	428	ST38	656RK	B2	635RK
24682FEC	618	373	ST38-1	ST38-1	ET38	ET38
24683FE	615	365	ST38	656RK	ST38	656RK
24683LFE	670	390	ST38	656RK	ST38	656RK
24683LFE1	730	420	ST38	656RK	ST38	656RK
24691FE	462	343	ST38	656RK	ET153	ET153
24696FE	570	347	ET161	-	ST1	2244K
24697FE	520	322	B2	635RK	ST1	2244K
24698FE	624	381	B1	632RF	B1	632RF
24710FE	540	408	STEM 95 X M12	ST710RK	ET153-1	ET153-1
24713FE	470	325	STEM 86 X M10	-	ET158	ET158
24715FE	423	305	STEM 71 X M10	-	ET158-1	ET158-1
24716FE	388	283	STEM 85 X M12	656R	ET153-2	ET153-2
24717FE	575	352	B1	632RF	ET34	ET34
24718FE	380	265	ET159	-	ET159	-
24720FE	600	435	STEM 69 X M14	ST720RK	ET113-1	ET113-1
24727FE	512	378	STEM 65 x M12	ST727RK	ET154	ET154
24740FE	452	299	STEM 81 X M12	-	ET158-2	ET158-2
24742FE	564	356	ST42	-	ET160	ET160
24743FE	575	346	ST10	ST10RK	B2	635RK
24744FE	609	361	ST10	ST10RK	ET17	ET17
24745FE	499	359	STEM 64 x M12	ST710RK	ET153	ET153
24746FE	605	360	ST1	2244K	ET17	ET17
24750FE	552	425	STEM 68 X M12	ST710RK	ET153-3	ET153-3
24776FE	587	362	ET172	-	CB34	-
24777FE	587	362	ET172	-	ET172	-
24780FE	613	450	STEM 68 x M12	ST710RK	ET113-1	ET113-1
24781FE	650	384	ST38	ST21RK	ET38-2	ET38-2
24788FE	560	341	ET113	-	ST39	ST39
24789FE	576	349	ST39	ST39	ET174	ET174
24795FE	441	290	ST21	ST21RK	ET153	-
24796FE	619	369	ST21	ST21RK	B2	635RK

All measurements are in mm unless otherwise stated



SHOCK ABSORBERS - FOAM CELL PRO

SPECIFICATIONS

Part Number	Extended (mm)	Compressed (mm)	Upper Mo0unt Type	Upper Replacement	Lower Mount Type	Lower Replacement	Seal Service Kit	Seat Insulator	Adjusting Rings
45080FE	552	358	ST38	656RK	ST38	656RK	45SK7220		
45081FE	631	400	B2	635RK	B2	635RK	45SK7220		
45081FEC	631	400	B2	635RK	B2	635RK	45SK7220		
45091FE	510	318	ST38	656RK	ST38	656RK	45SK7220		
45091LFE	557	341	ST38	656RK	ST38	656RK	45SK7220		
45091LFE1	597	361	ST38	656RK	ST38	656RK	45SK7220		
45091LFE3	860	492	ST38	656RK	ST38	656RK	45SK7220		
45094FE	658	416	B2	635RK	ET38	ET38	45SK7220		
45094LFE	718	446	B2	635RK	ET38	ET38	45SK7220		
45094LFE1	760	467	B2	635RK	ET38	ET38	45SK7220		
45094LFE3	860	516	B2	635RK	ET38	ET38	45SK7220		
45095FE	630	398	ET104	ET104	ET69	ET69	45SK7220		
45095FEC	630	398	ET104	ET104	ET69	ET69	45SK7220		
45635FE	485	343	B1	632RF	B1	632RF	45SK7220		
45636FE	587	375	B1	632RF	B1	632RF	45SK7220		
45636FEC	587	375	B1	632RF	B1	632RF	45SK7220		
45637FE	577	383	ST1	2244K	B2	635R	45SK7220		
45640FE	564	377	ET38	ET38	ST38	656RK	45SK7220		
45650FE	592	380	ST10	635RK	B2	635RK	45SK7220		
45650FEC	592	380	B2	635RK	B2	635RK	45SK7220		
45661FE	533	363	ST1	2244K	ET38	ET38	45SK7220		
45667FE	382	277	ST1	2244K	ET17	ET17	45SK6520		
45682FE	618	383	ST38	656RK	ET38	ET38	45SK7220		
45682FEC	618	383	ST38-1	ST38-1	ET38	ET38	45SK7220		
45682LFE	670	409	ST38	656RK	ET38	ET38	45SK7220		
45682LFE1	730	439	ST38	656RK	ET38	ET38	45SK7220		
45682LFE3	860	504	ST38	656RK	ET38	ET38	45SK7220		
45683FE	615	370	ST38	656RK	ST38	656RK	45SK7220		
45683LFE	670	397	ST38	656RK	ST38	656RK	45SK7220		
45683LFE1	730	427	ST38	656RK	ST38	656RK	45SK7220		

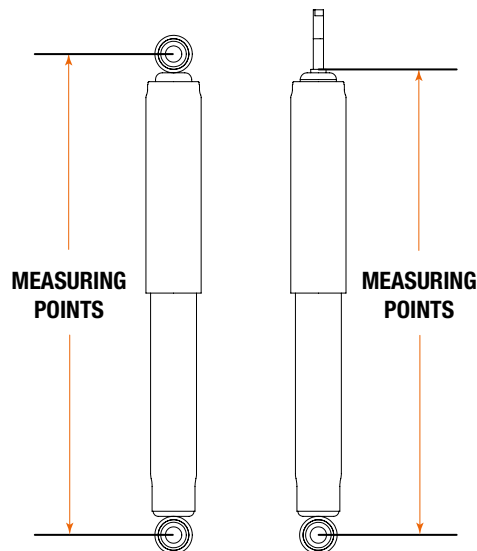

All measurements are in mm unless otherwise stated



Part Number	Extended (mm)	Compressed (mm)	Upper Mo0unt Type	Upper Replacement	Lower Mount Type	Lower Replacement	Seal Service Kit	Seat Insulator	Adjusting Rings
45691FE	462	342	ST38	656RK	ET153	ET153	45SK6520	45RSS001	45TAR001
45698FE	626	414	B1	632RF	B1	632RF	45SK7220		
45698FEC	626	414	B1	632RF	B1	632RF	45SK7220		
45710FE	540	408	STEM 95 x M12	ST710RK	ET153-1	ET153-1	45SK6520	45RSS001	45TAR001
45716FE	389	283	STEM 86 x M12	656RK	ET153-2	ET153-2	45SK7220	45RSS004	45TAR002
45717FE	572	369	B1	632RF	ET34	ET34	45SK7220		
45720FE	600	435	STEM 71 x M14	ST720RK	ET113-1	ET113-1	45SK7218	45RSS002	45TAR002
45727FE	512	378	STEM 65 x M12	ST727RK	ET154	ET154	45SK7220	45RSS005	45TAR002
45740FE	452	302	STEM 81 x M12	-	ET158-2	ET158-2	45SK7220	45RSS003	45TAR002
45742FE	564	357	ST42	-	ET160	ET160	45SK7220		
45743FE	576	382	ST10	ST10RK	ET38	ET38	45SK7220		
45744FE	610	399	ST10	ST10RK	ET17	ET17	45SK7220		
45745FE	499	359	STEM 64 x M12	ST710RK	ET153-1	ET153-1	45SK6520	45RSS001	45TAR001
45746FE	605	397	ST1	2244K	ET17	ET17	45SK6520		
45750FE	552	425	STEM 68 x M12	ST710RK	ET153-3	ET153-3	45SK6520	45RSS001	45TAR001
45751FE	575	381	ST38	656RK	B1	632RF	45SK7220		
45752FE	617	413	CB35	CB35	B1	632RF	45SK7220		
45780FE	613	450	STEM 68 X M12	ST710RK	ET113-1	ET113-1	45SK7218	45RSS002	45TAR002
45781FE	650	421	ST21	ST21RK	ET38-2	ET38-2	45SK7220		
45795FE	447	315	ST21	ST21RK	ET38-1	ET38-1	45SK7220		
45796FE	615	381	ST21	ST21RK	ET38	ET38	45SK7220		



ISHOCKTOOL001 Multi-tool for shock absorber service and strut ride height adjustment

All measurements are in mm unless otherwise stated



Part Number	Extended (mm)	Compressed (mm)	Upper Mount Type	Upper Replacement	Lower Mount Type	Lower Replacement
3501	550	345	B9	B9MK	B9	B9MK
3502	655	394	ET65	-	ET65	-
3511	525	310	ST1	2244K	ST1	2244K
3517	609	368	B6	-	B6	-
3521	540	340	ST1	2244K	B9	B9MK
3521S	487	293	ST1	2244K	ST1	2244K
3522	541	331	B1	632RF	B1	632RF
3523	458	322	B9	B9MK	B9	B9MK
3524	648	423	B9	B9MK	B9	B9MK
3525	748	443	B9	B9MK	B9	B9MK
3530	445	290	ET17	ET17	ET17	ET17
3532	677	439	ST1	2244K	ET57	-
3533	613	368	ET109	-	B9	B9MK
3534	577	350	ET17	ET17	B1	632RF
3536	487	292	ST1	2244K	ST1	2244K
3540	480	298	B1	632RF	ET65	-
3541	528	332	ET65	-	ET65	-

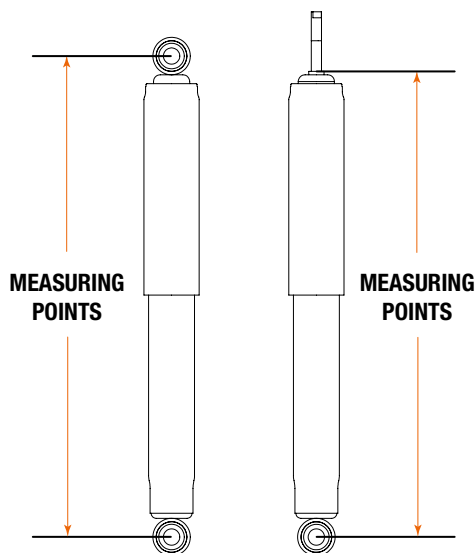

All measurements are in mm unless otherwise stated

SHOCK ABSORBER MOUNT TYPE



MOUNT TYPE

Type	A Diameter	B Length	
B1	16	36	
B2	19	43.5	
B5	15.5	33	
B6	16	36	Adaptor
B9	16	36	Adaptor

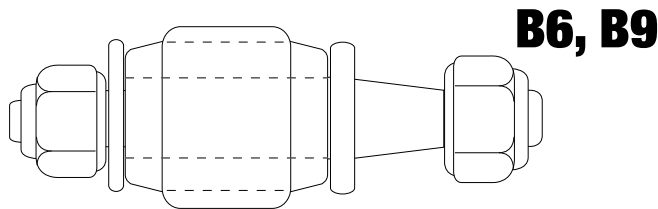
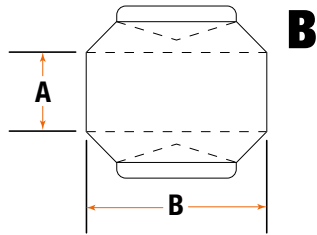

Type	A Diameter	B Length	C Length
CB20	13	95	77
CB34	11	97	75
CB35	10	90	80
CB7	11.5	78	62

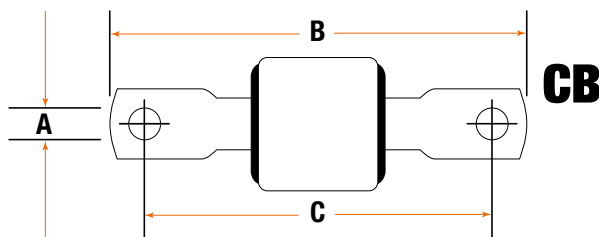

Type	A Diameter	B Length	C Length
ST1	10	26	60
ST10	12	39	64
ST21	17	59	84
ST38	14	43	70
ST38-1	14	43	70
ST42	Rectangle M12	44	80
ST6	11	34	65

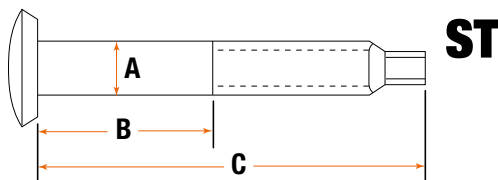

Type	A Diameter	B Length	
ET104	20	43	
ET109	10	24.1	
ET113	16	38.5	
ET113-1	16	38.5	Sleeved
ET141	12	41	
ET142	16	36.5	
ET153	14	40	Sleeved
ET153-1	14	40	Sleeved
ET153-2	14	41.5	Sleeved
ET153-3	14	41.5	Sleeved
ET154	16	38	Sleeved
ET158	14	50	Sleeved
ET158-1	14	50	Sleeved
ET158-2	14	50	Sleeved
ET159	14	48	Sleeved
ET160	14	53	Sleeved
ET161	16	70	
ET17	12	31.5	
ET172	12.4	43.5	
ET173	13	42.5	
ET19	12	46	
ET24	12.5	36	
ET34	14	41.5	
ET36	19	44	
ET38	19	45.5	
ET38-1	14	38	
ET38-2	12	39	
ET57	10	26.1	
ET61	12	46	
ET65	12	36	
ET69	12	40	
ET83	12	37.5	

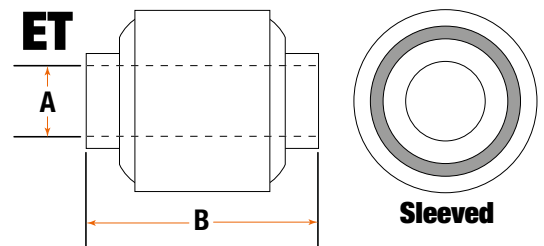

All measurements are in mm unless otherwise stated



U-BOLTS

Part Number	Type	Length	I/D	Thread	Tension Nm
415UBK	Round	215	83	M14 X 1.5 X 100	125
416UBK	Round	230	83	M14 X 1.5 X 100	125
416UBKL	Round	250	83	M14 X 1.5 X 100	125
417UBK	Round	220	88	M14 X 1.5 X 80	125
436UBK	Square	230	73	M14 X 1.5 X 100	125
437UBK	Square	175	62	M14 X 1.5 X 100	125
449UBK	Square	230	83	M14 X 1.5 X 100	125
451UBK	Round	190	75	M12 X 1.5 X 75	75
452UBK	Square	120	63	M12 X 1.5 X 75	75
453UBK	Round	230	97	M14 X 1.5 X 100	125
512UBK	Round	160	70	M12 X 1.5 X 65	75
654UBK	Round	165	82	M12 X 1.5 X 75	75
655UBK	Round	140	70	M12 X 1.5 X 65	75
668UBK	Square	230	73	M14 X 1.5 X 100	125
669UBK	Square	230	73	M14 X 1.5 X 100	125
670UBK	Round	230	95	M14 X 1.5 X 100	125
678UBK	Square	200	62	M14 X 1.5 X 70	125
788UBK	Square	190	63	M12 X 1.25 X 65	75
1100UBK	Round	230	110	M14 X 1.5 X 100	125
1100UBKL	Round	265	110	M14 X 1.5 X 100	125
1102UBK	Square	55	72	M12 X 1.5 X 65	75
1103UBK	Round	185	72	M14 X 1.5 X 100	125

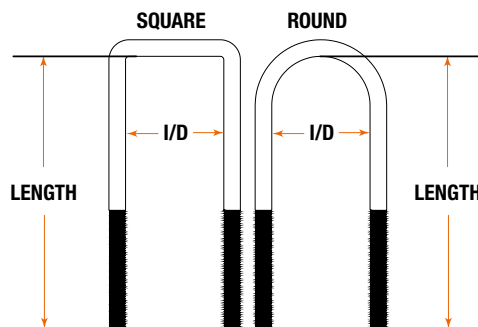

LOAD PLUS

Part Number	Width	Thickness	Length	Mounting Kit	U-Bolt
LP1	60	12	425	LP3-1	LP3-2
LP2	60	12	420	LP3-1	LP3-2
LP3	60	12	442	LP3-1	LP3-2
LP4	70	12	442	LP4-1	LP4-2
LP5	50	8	310	LP5-1	LP5-2
LP7	75	12	438	LP7-1	LP7-2
LP9	70	16	435	LP9-1	LP9-2

All measurements are in mm unless otherwise stated

SUSPENSION ARM BUSH KITS



POLYURETHANE SUSPENSION ARM BUSH KITS

Model	Part Number	Contents	Position	Qty Per Kit
LAND ROVER / RANGE ROVER PRE 1986	801K	802UT	Radius Arm - Diff	4
		803	Radius Arm - Chassis	4
		806UT	Trailing Arm Chassis	2
		807UT	Trailing Arm Diff	2
		804UT	Front Panhard	2
		860	Flange Plate	2
		808UT	Trailing Arm - Chassis	2
		861	Washer To Fit 808UT	4
LAND ROVER / RANGE ROVER 1986-ON DEFENDER LATE	811K	812UT	Radius Arm - Diff	4
		813	Radius Arm - Chassis	4
		806UT	Trailing Arm Chassis	2
		807UT	Trailing Arm Diff	2
		814UT	Front Panhard	2
		815	Flange Plate	2
		818UT	Trailing Arm - Chassis	2
		861	Washer To Fit 818UT	4
LAND ROVER / DEFENDER EARLY	821K	802UT	Radius Arm - Diff	4
		813	Radius Arm - Chassis	4
		806UT	Trailing Arm Chassis	2
		807UT	Trailing Arm Diff	2
		814UT	Front Panhard	2
		815	Flange Plate	2
		818UT	Trailing Arm - Chassis	2
		861	Washer To Fit 818UT	4
NISSAN PATROL Y60 PRE 1989	831K	832UT	Radius Arm - Diff	4
		833	Radius Arm Chassis	4
		836UT	Trailing Arm	8
		834UT	Panhard	2
		835	Panhard	4

All measurements are in mm unless otherwise stated



SUSPENSION ARM BUSH KITS / SUSPENSION ARM BUSHES

SPECIFICATIONS

Model	Part Number	Contents	Position	Qty Per Kit
NISSAN PATROL Y60 1989 - ON	839K	832UT	Radius Arm - Diff	4
		833	Radius Arm Chassis	4
		836UT	Trailing Arm	8
		834UT	Panhard	2
		840UT	Panhard	2
TOYOTA LANDCRUISER 80/105	847K	832UT	Radius Arm - Diff	4
		846UT	Radius Arm Chassis	2
		844UT	Trailing Arm Upper	4
		843UT	Trailing Arm Lower	4
		841UT	Front Panhard	2
		845UT	Rear Panhard	2



RUBBER SUSPENSION ARM BUSHES

Part No	Application	Location	O/D	I/D	Length	Material
834RT	Nissan Patrol Y60 GQ / Y61 GU	Front & Rear Panhard Rod	48	14	48	Rubber
836RT	Nissan Patrol Y60 GQ / Y61 GU	Upper & Lower Trailing Arm	50	14	60	Sleeved Rubber
840RT	Nissan Patrol Y60 GQ / Y61 GU	Front & Rear Panhard Rod	48	26	48	Rubber
841RT	Toyota Landcruiser 80 / 105	Front Panhard Rod	40	16	50	Sleeved Rubber
843RT	Toyota Landcruiser 80 / 105	Lower Trailing Arm	54	18	60	Sleeved Rubber
844RT	Toyota Landcruiser 80 / 105	Upper Trailing Arm	50	18	60	Sleeved Rubber
845RT	Toyota Landcruiser 80 / 105	Rear Panhard Rod	40	18	50	Sleeved Rubber
848RT	Nissan Patrol Y60 GQ / Y61 GU	Front & Rear Panhard Rod	61	14	65	Spherical Bearing



All measurements are in mm unless otherwise stated



Part No.	Page
1002K	72, 74
1084UK	128
1085UK	127, 130, 132
1100UBKL	77
1100UBK	77
1102UBK	58
1103UBK	49
1104UBK	91
1141-1	125, 127
1141	125, 127, 128, 130, 132
1142	125, 127, 128, 130, 132
1144SK	72, 74, 77, 78, 80, 125, 127, 128, 130, 132, 134, 138
1144	125, 127, 128, 130, 132, 134, 138
1145SK	42, 43, 44, 45, 46
1146RK	98, 99
1147	21, 53
1148	29
1149	49
1150	147
1151UK	111
1185UK	125
1188UK	150, 151
1189	150, 151
1190UK	152
1191UK	146
1192K	146
1193UK	21, 53
1194K	21, 53
1196UK	147
1197K	147
1198K	110, 112, 142, 143, 144, 145
12075GR	69, 70, 69, 70
12080GR	42, 43, 44, 45, 46
12081GRC	106, 112, 125, 126
12081GR	106, 112, 125, 126
12082GR	55, 56, 59, 61
12083GR	100, 101
12085GR	97
12086GR	97
12087GR	22, 23, 26, 32, 49, 50, 57, 60, 62, 64, 65, 87
12088GR	106, 107, 108
12089GR	100, 101
12091GR	72, 74, 77, 78, 80, 123, 125, 127, 128, 130, 132
12094GR	72, 74, 78, 80, 127, 128, 130, 132
12095GRC	19, 20, 21, 51, 52, 53
12095GR	19, 20, 21, 51, 52, 53
12635GRC	114, 115, 116, 117
12635GR	114, 115, 116, 117
12636GRC	22, 26, 27, 28, 29, 55, 56, 58, 59, 60, 64, 83, 87, 88, 104, 114, 115, 116, 117, 118

Part No.	Page
12636GR	22, 26, 27, 28, 29, 55, 56, 58, 59, 60, 64, 83, 87, 88, 104, 114, 115, 116, 117, 118
12637GRC	32, 108, 118, 120, 122, 126
12637GR	32, 108, 118, 120, 122, 126, 151
12639GRC	104, 105
12639GRS	123
12639GR	104, 105
12640GR	42, 43, 44, 45, 46
12643GR	24, 27
12644GR	24, 25
12645GRC	61, 65, 66
12645GR	61, 65, 66, 62
12648GR	76, 77
12650GRC	105, 107, 111, 112, 120, 122
12650GR	105, 107, 111, 112, 120, 122, 123
12652GR	150
12658GR	100, 101
12661GRS	96
12661GR	76, 109, 141
12665GR	33, 34, 36
12666GR	33
12667GR	19, 20, 25, 28, 51, 52, 68, 83, 96
12669GR	34
12670GR	36
12671GR	23, 68
12682GRC	110, 142, 143, 144
12682GR	134, 138
12683GR	134, 138
12691GR	109, 141
12696GR	124
12697GR	124
12698GRC	57, 91, 92
12698GR	57, 68, 91, 92, 150, 151
12710GR	110, 112, 142, 144, 145, 146
12711GR	38, 39
12712GR	38, 39
12713GR	63
12714GR	63
12715GR	58, 66
12716GR	85, 86, 89, 90, 91, 93
12717GR	89, 90, 93
12718GR	85, 86
12720GR	140
12721GR	102
12722GR	102
12725GR	152
12726GR	152
12727GR	21, 53
12740GR	82
12742GR	82
12743GRC	145
12743GR	145

Part No.	Page
12744GR	146
12745GR	29, 30, 31
12746GRC	30, 31
12746GR	30, 31
12747GR	18, 95
12748GR	18, 95
12749GR	49, 50
12750GR	143
12751GR	35
12751LGR	35
12752GR	35
12752LGR	35
12755GR	148, 148
12759GR	99
12760GR	99
12764GR LH	111
12764GR RH	111
12765GR	149
12774GR	37
12775GR	37
12776GR	47
12777GR	47
12791GR	88, 92
12795GR	137
12796GR	137, 140
24080FE	42, 43, 44, 45, 46
24081FEC	106, 112, 125, 126
24081FE	106, 112, 125, 126
24082FE	55, 56, 59, 61
24087FE	22, 23, 26, 32, 57, 60, 62, 64, 65, 87
24088FE	106, 107, 108
24091FE	72, 74, 77, 78, 80, 123, 125, 127, 128, 130, 132
24091LFE1	72, 74, 78, 80
24091LFE	72, 74, 78, 80
24094FE	72, 74, 78, 80, 127, 128, 130, 132
24094LFE1	72, 74, 78, 80
24094LFE	72, 74, 78, 80, 127, 128, 130, 132
24095FEC	19, 20, 21, 51, 52, 53
24095FE	19, 20, 21, 51, 52, 53
24635FEC	114, 115, 116, 117
24635FE	114, 115, 116, 117
24636FEC	22, 26, 27, 28, 29, 55, 56, 58, 59, 60, 64, 83, 87, 104, 114, 115, 116, 117, 118
24636FE	22, 26, 27, 28, 29, 55, 56, 58, 59, 60, 64, 83, 87, 104, 114, 115, 116, 117, 118
24637FEC	108, 118, 120, 122, 126
24637FE	108, 118, 120, 122, 126, 151
24639FES	123
24639FE	104, 105
24640FE	42, 43, 44, 45, 46
24643FE	24, 24, 25
24645FEC	61, 65, 66

Part No.	Page
24645FE	61, 65, 66
24646FE	62
24648FE	76, 77
24650FEC	105, 107, 111, 112, 120, 122
24650FE	105, 107, 111, 112, 120, 122, 123
24652FE	150
24661FES	96
24661FE	76, 109, 141
24665FE	33, 34, 36
24666FE	33
24667FE	19, 20, 25, 28, 51, 52, 68, 83, 96
24682FEC	110, 142, 143, 144
24682FE	134, 138
24682LFE1	134, 138
24682LFE	134, 138
24683FE	134, 138
24683LFE1	134, 138
24683LFE	134, 138
24691FE	109
24696FE	124
24697FE	124
24698FEC	57, 91
24698FE	57, 91, 150, 151
24710FE	110, 112, 142, 144, 145, 146
24713FE	63
24715FE	58, 66
24716FE	85, 86, 89, 90, 91, 93
24717FE	89, 90, 93
24718FE	85, 86
24720FE	140
24727FE	21, 53
24740FE	82
24742FE	82
24743FEC	145
24743FE	145
24744FE	146
24745FE	29, 30, 31
24746FEC	30, 31
24746FE	30, 31, 143
24776FE	47
24777FE	47
24780FE	147
24781FE	147
24788FE	54
24789FE	54
24795FE	137
24796FE	137, 140
343LH / RH	114, 116
344	116
345	116
346	114, 116
347	116
348LH / RH	115, 117, 118, 120, 122, 126
3501	80



PRODUCT CODE

PRODUCT QUICK REFERENCE

Part No.	Page
3502	47
3511	45, 46, 77, 78, 80
3517	55, 56, 57, 59, 60, 61, 62
351	115, 117, 118, 120, 122, 126
3521S	99
3521	104, 105
3522	69, 70, 76
3523	114, 115, 116, 117
3524	118, 120, 122, 123, 124, 125, 126, 128, 130, 134, 138
3525	127, 128, 130, 132
3530	97
3532	42, 43, 44
3533	106, 107, 108
3534	72, 74
3535	83
3536	72, 74
353LH / RH	49, 76, 76, 77, 117, 118, 120, 122, 126
3540	33, 34, 35, 36
3541	35
354	122, 126
355K	69
384	104, 105
385	104, 105, 107
386-1	19, 20, 51, 52, 106
386-2	27, 28, 104, 105, 107
386-3	111, 112
386	104, 105, 107
387-1	21, 27, 28, 29, 53, 56, 57, 58, 106, 111, 112
415UBK	19, 27, 51, 111, 114, 115, 116, 117, 118, 120, 122, 125, 152
416UBKL	128, 130, 132
416UBK	93, 126, 127, 128, 130, 132
417UBK	20, 21, 28, 52, 53
436UBK	76, 118, 120, 122, 126
437UBK	89, 90, 104, 105, 106, 107, 112, 146
449UBK	117
45080FE	42, 43, 44, 45, 46
45081FEC	112, 125, 126
45081FE	112, 125, 126
45091FE	72, 74, 78, 80, 125, 127, 128, 130, 132
45091LFE1	72, 74, 78, 80
45091LFE	72, 74, 78, 80
45094FE	72, 74, 78, 80, 127, 128, 130, 132
45094LFE1	72, 74, 78, 80
45094LFE	72, 74, 78, 80, 127, 128, 130, 132
45095FEC	19, 20, 21, 51, 52, 53
45095FE	19, 20, 21, 51, 52, 53
451UBK	22, 23, 26, 55, 56, 57, 59, 60, 64, 69, 70
452UBK	69, 70

Part No.	Page
453UBK	69, 70
45635FE	114, 115, 116, 117
45636FEC	29, 114, 115, 116, 117, 118
45636FE	29, 114, 115, 116, 117, 118
45637FEC	118, 120, 122, 126
45637FE	118, 120, 122, 126
45640FE	42, 43, 44, 45, 46
45650FEC	112, 120, 122
45650FE	112, 120, 122
45661FE	109, 141
45667FE	19, 20, 51, 52
45682FEC	110, 142, 143, 144
45682FE	134, 138
45682LFE1	134, 138
45682LFE	134, 138
45683FE	134, 138
45683LFE1	134, 138
45683LFE	134, 138
45691FE	109, 141
45698FEC	91
45698FE	91
45710FE	110, 112, 142, 144, 145, 146
45716FE	89, 90, 91, 93
45717FE	89, 90, 93
45720FE	140
45727FE	21, 53
45740FE	82
45742FE	82
45743FEC	145
45743FE	145
45744FE	146
45745FE	29, 30, 31
45746FEC	30, 31
45746FE	30, 31
45750FE	143
45751FE	35
45752FE	35
45780FE	147
45781FE	147
45795FE	137
45796FE	137, 140
470	69, 70
512UBK	33
654UBK	92, 97
655UBK	97
664	69, 70
665	70
667	76, 77
669UBK	76
670UBK	76
678UBK	29, 89, 90, 104, 105, 106, 112, 147, 150, 151
704TUK	91
704UK	87, 88
713UK	114, 116
714UK	114, 116

Part No.	Page
715STUK	64
715TUK	56, 57, 58, 60
715UK	55, 59
718UK	76
719UK	49, 76, 77, 115, 117, 118, 120, 122, 126
720UK	126
721UK	69
722UK	69, 70
724UK	70
728TUK	28
728UK	26, 27
732UK	104, 105
733UK	104, 105, 107
734UK	97
747UK	22, 23
756UK	19, 51
758UK	106
759UK	20, 52
762UK	33
767UK	111, 112
769UKL	92
769UK	89, 90, 93
770UK	29
788UBK	87, 88
791	22, 23, 26
792	22, 23, 26
794	19, 51
795	55, 56, 57, 58, 59, 60, 64
796	55, 59, 60, 64
797-1	89, 90, 93
797-2	92
797-3	91
797	87, 88
798	87, 88, 92
801K	45
811K	42, 43, 44, 45, 46
821K	42, 43, 44
831K	73, 75
839K	73, 75, 79, 81
847K	135, 139
ADL001	134, 138
ADL003	72, 74, 77, 78
ADL005	80
BHOSE001	134, 138
BHOSE002	134, 135, 138, 139
BHOSE003	72, 74, 77, 78, 80
BHOSE004	73, 75, 79, 81
BHOSE005	77, 78, 80
BRACKET100	137
CPLATE001	134, 138
CPLATE003	72, 74, 77, 78, 80
DHOSE350	32
FOR001AKF	21, 53
FOR001AKG	21, 53
FOR001AKP	21, 53
FOR001A	21, 53
FOR001BKF	21, 53

Part No.	Page
FOR001BKG	21, 53
FOR001BKP	21, 53
FOR001B	21, 53
FOR001CKF	21, 53
FOR001CKG	21, 53
FOR001CKP	21, 53
FOR001C	21, 53
FOR001S	21, 53
FOR002A	21, 53
FOR002B	21, 53
FOR002C	21, 53
HILFR05F	21, 29, 30, 31, 53, 58, 66, 82, 85, 86, 89, 90, 91, 93, 109, 110, 112, 140, 141, 142, 143, 144, 145, 146, 147
HILFR05	21, 29, 30, 31, 38, 39, 53, 58, 66, 82, 85, 86, 89, 90, 91, 93, 109, 110, 111, 112, 140, 141, 142, 143, 144, 145, 146, 152
HILFR10F	21, 29, 30, 31, 53, 58, 66, 82, 85, 86, 89, 90, 91, 93, 109, 110, 112, 140, 141, 142, 143, 144, 145, 146, 147
HILFR10	21, 29, 30, 31, 38, 39, 53, 58, 66, 82, 85, 86, 89, 90, 91, 93, 109, 110, 111, 112, 140, 141, 142, 143, 144, 145, 146, 152
HILFR15F	21, 29, 30, 31, 53, 58, 66, 82, 85, 86, 89, 90, 91, 93, 109, 110, 112, 140, 141, 142, 143, 144, 145, 146, 147
HILFR15	21, 29, 30, 31, 38, 39, 53, 58, 66, 82, 85, 86, 89, 90, 91, 93, 109, 110, 111, 112, 140, 141, 142, 143, 144, 145, 146, 152
HOLD004BD/S	22, 23, 27
HOLD004BKF1	26
HOLD004BKG1	26
HOLD004BKG2	27
HOLD004BN/S	22, 23, 27
HOLD004CD/S	22, 23, 26, 27
HOLD004CKF1	26
HOLD004CKG1	26
HOLD004CKG2	27
HOLD004CN/S	22, 23, 26, 27
HOLD005A	23, 27
HOLD005BKF	22
HOLD005BKG	22
HOLD005CKF	22
HOLD005CKG	22
HOLD006BKF	28
HOLD006BKG	28
HOLD006B	28
HOLD006CKF	28
HOLD006CKG	28
HOLD006C	28



Part No.	Page
HOLD007BKF	23
HOLD007BKG	23
HOLD007	23
HOLD008BKF1	25
HOLD008BKF	24
HOLD008BKG1	25
HOLD008BKG	24
HOLD008B	24, 25, 31, 83
HOLD008CKF1	25
HOLD008CKF	24
HOLD008CKG1	25
HOLD008CKG	24
HOLD008C	24, 25, 31
HOLD009	24, 25
HOLD010	28
HOLD020A	29, 30, 31
HOLD020BKF	31
HOLD020BKG	31
HOLD020BKP	31
HOLD020B	29, 30, 31
HOLD020CKF	31
HOLD020CKG	31
HOLD020CKP	31
HOLD020C	29, 30, 31
HOLD020S	29, 30, 31
HOLD021AKF	29
HOLD021AKG	29
HOLD021AKP	29
HOLD021A	29
HOLD021BKF	29
HOLD021BKG	29
HOLD021BKP	29
HOLD021B	29
HOLD021CKF	29
HOLD021CKG	29
HOLD021CKP	29
HOLD021C	29
HOLD022AKF	30
HOLD022AKG	30
HOLD022AKP	30
HOLD022A	30
HOLD022BKF	30
HOLD022BKG	30
HOLD022BKP	30
HOLD022B	30
HOLD022CKF	30
HOLD022CKG	30
HOLD022CKP	30
HOLD022C	30
HOLD022SKF	30
HOLD022SKG	30
HOLD022SKP	30
HOLD022S	30
HYUND003BKG	32
HYUND003B	32
HYUND004	32
IAP001	89, 90

Part No.	Page
ICAMBER12	18, 94, 95, 100, 101
ICAMBER14	67, 84, 102, 103
IMAZ001BKF1	151
IMAZ001BKF	150
IMAZ001BKG1	151
IMAZ001BKG	150
IMAZ001B	150, 151
IMAZ002B	150, 151
ISB200F	140
ISB200R	140
ISB600F	82
ISB600R	82
JEEP003BKF	33
JEEP003B	34, 36, 36
JEEP004BD/S	33
JEEP004BN/S	33
JEEP006BKG	36
JEEP006B	36
JEEP006CKG	36
JEEP007BKG	34
JEEP007B	34
JEEP008B	34
JEEP012BKG	37
JEEP012B	37
JEEP013B	37
JEEP014BKG1	38
JEEP014BKG	38
JEEP014B	38
JEEP014C	38
JEEP015B	38
JEEP016B	33, 36
JEEP017AKG	35
JEEP017AKP	35
JEEP017BKG	35
JEEP017BKP	35
JEEP017B	35
JEEP017C	35
JEEP018A	35
JEEP018B	35
JEEP019BKGL	35
JEEP019B	35
JEEP020B	35
JEEP03BKG	33
JKBKITL	35
KIA006B	40
KIA007B	40
LADA001B	41
LADA002B	41
LAND005BKF	44
LAND005BKG	44
LAND005BKP	44
LAND005B	44
LAND006BKF	44
LAND006BKG	44
LAND006BKP	44
LAND006B	43, 44
LAND006CKF	44

Part No.	Page
LAND006CKG	44
LAND006CKP	44
LAND006C	43, 44
LAND007BKF	43
LAND007BKG	43
LAND007BKP	43
LAND007B	43, 45, 46
LAND007CKF	43
LAND007CKG	43
LAND007CKP	43
LAND008B	44
LAND009BKF	42, 45, 46
LAND009BKG	42, 45, 46
LAND009BKP	42, 45, 46
LAND009B	42, 45, 46, 47
LAND009CKF	42, 45, 46
LAND009CKG	42, 45, 46
LAND009CKP	42, 45, 46
LAND011B	42, 45, 46, 47
LAND011C	42, 45, 46, 47
LAND014BKF	47
LAND014BKG	47
LAND014B	47
LAND014CKF	47
LAND014CKG	47
LAND019B	48
LAND019C	48
LAND020B	48
LAND020C	48
LC70F30	125, 127, 128, 130, 132
LCF20	109, 134, 138, 141
LCF30	109, 134, 138, 141
LCPR20	110, 142, 143, 144
LCPR25	110, 142, 143, 144
LCR15	135, 137, 139
LCR30	135, 137, 139
LP2	89, 90, 91, 92, 93, 104, 105, 106, 107, 111, 112
LP3	19, 20, 21, 22, 23, 26, 27, 51, 52, 53, 69, 70, 87, 88, 146
LP4	49, 55, 56, 57, 58, 59, 60, 64, 76, 77, 114, 115, 116, 117, 118, 120, 122, 126, 127, 147, 152
LP5	97
LP9	128, 130, 132
LTA001	135, 139
LTA003	73, 75, 79, 81
MAH001	49, 50
MAH002BKG	49
MAH002B	49
MAH003BKG	50
MAH003B	50
MAZDA003A	26
MAZDA005	19, 20, 22, 26, 51, 52
MAZDA006AKF	19, 51
MAZDA006AKG	19, 51
MAZDA006AKP	19, 51

Part No.	Page
MAZDA006A	19, 51
MAZDA006BKF	19, 51
MAZDA006BKG	19, 51
MAZDA006BKP	19, 51
MAZDA006B	19, 51
MAZDA006CKF	19, 51
MAZDA006CKG	19, 51
MAZDA006CKP	19, 51
MAZDA006C	19, 51
MAZDA006DKF	19, 51
MAZDA006DKG	19, 51
MAZDA006DKP	19, 51
MAZDA006D	19, 51
MAZDA014	20, 52
MAZDA041AKF	20, 52
MAZDA041AKG	20, 52
MAZDA041AKP	20, 52
MAZDA041A	20, 52
MAZDA041BKF	20, 52
MAZDA041BKG	20, 52
MAZDA041BKP	20, 52
MAZDA041B	20, 52
MAZDA041CKF	20, 52
MAZDA041CKG	20, 52
MAZDA041CKP	20, 52
MAZDA041C	20, 52
MAZDA041DKF	20, 52
MAZDA041DKG	20, 52
MAZDA041DKP	20, 52
MAZDA041D	20, 52
MERC015BKF	54
MERC015B	54
MERC016B	54
MITSO13	55, 59, 60, 61, 62
MITSO15BKF1	57
MITSO15BKF	56
MITSO15BKG1	57
MITSO15BKG	56
MITSO15CKF1	57
MITSO15CKF	56
MITSO15CKG1	57
MITSO15CKG	56
MITSO15C	56, 57
MITSO18BKF1	55, 59
MITSO18BKF2	60
MITSO18BKF	64
MITSO18BKG1	55, 59
MITSO18BKG2	60
MITSO18BKG	64
MITSO18B	55, 56, 57, 59, 60, 64
MITSO18CKF1	55, 59
MITSO18CKF2	60
MITSO18CKF	64
MITSO18CKG1	55, 59
MITSO18CKG2	60
MITSO18CKG	64
MITSO18C	55, 56, 57, 59, 60, 64



PRODUCT CODE

PRODUCT QUICK REFERENCE

Part No.	Page
MITSO19	59, 60, 61, 62, 64, 65
MITSO20BKF1	61
MITSO20BKF2	62
MITSO20BKF	65
MITSO20BKG1	61
MITSO20BKG2	62
MITSO20BKG	65
MITSO20B	61, 62, 65
MITSO20CKF1	61
MITSO20CKF2	62
MITSO20CKF	65
MITSO20CKG1	61
MITSO20CKG2	62
MITSO20CKG	65
MITSO20C	61, 62, 65
MITSO22BKF1	61
MITSO22BKF2	62
MITSO22BKF	65
MITSO22BKG1	61
MITSO22BKG2	62
MITSO22BKG	65
MITSO22B	61, 62, 65
MITSO25B	68
MITSO31BKG1	68
MITSO31BKG	68
MITSO31	68
MITSO34B	67
MITSO35B	67
MITSO38AKG	63
MITSO38BKG	63
MITSO38B	63
MITSO38CKG1	63
MITSO38CKG2	63
MITSO38CKG	63
MITSO38C	63
MITSO39A	63
MITSO39B	63
MITSO39C	63
MITSO40A	58, 66
MITSO40B	58, 66
MITSO40C	58, 66
MITSO40S	58, 66
MITSO41AKF	58
MITSO41AKG	58
MITSO41A	58
MITSO41BKF	58
MITSO41BKG	58
MITSO41B	58
MITSO41CKF	58
MITSO41CKG	58
MITSO41C	58
MITSO42AKF	66
MITSO42AKG	66
MITSO42A	66
MITSO42BKF	66
MITSO42BKG	66
MITSO42B	66

Part No.	Page
MITSO42CKF	66
MITSO42CKG	66
MITSO42C	66
MITSO42SKF	66
MITSO42SKG	66
MITSO42S	66
NISS003BD/S	69
NISS003BKG	69
NISS003BN/S	69
NISS004BD/S	69, 70
NISS004BN/S	69, 70
NISS005BD/S	70
NISS005BKG	70
NISS005BN/S	70
NISS007BKF	73
NISS007BKG	73
NISS007BKP	73
NISS007B	72
NISS008B	72
NISS009BKF1	73
NISS009BKF	73, 75
NISS009BKG1	73
NISS009BKG	73, 75
NISS009BKP1	73
NISS009BKP	73, 75
NISS009B	72, 74
NISS009CKF	75
NISS009CKG	75
NISS009CKP	75
NISS009C	74, 77, 78, 80
NISS010B	72, 75
NISS010C	72, 75, 80
NISS011CD/S	76
NISS011CKF	76
NISS011CKG	76
NISS011CN/S	76
NISS011DKF	76
NISS011DKG	76
NISS012CD/S	76, 77
NISS012CN/S	76, 77
NISS012DD/S	76, 77
NISS012DN/S	76, 77
NISS013	87
NISS014AD/S	87, 88
NISS014AKF	87
NISS014AKG	87
NISS014AN/S	87, 88
NISS014BD/S	87, 88
NISS014BKF	87
NISS014BKG	87
NISS014BN/S	87, 88
NISS014CD/S	87, 88
NISS014CKF	87
NISS014CKG	87
NISS014CN/S	87, 88
NISS017	83
NISS018BKF	83

Part No.	Page
NISS018BKG	83
NISS018B	83
NISS018CKF	83
NISS018CKG	83
NISS020B	78
NISS020CKF	75
NISS020CKG	75
NISS020CKP	75
NISS020C	75, 78, 80
NISS020D	75, 78, 80
NISS024B	77, 78, 80
NISS024CKF	81
NISS024CKG	81
NISS024CKP	81
NISS024DKF	75
NISS024DKG	75
NISS024DKP	75
NISS025AKG	88
NISS025BKG	88
NISS025CKG	88
NISS025	88
NISS026BKF1L	81
NISS026BKF1	81
NISS026BKFL	73, 75, 79, 81
NISS026BKF	73, 75, 79, 81
NISS026BKP1L	81
NISS026BKP1	81
NISS026BKPL	73, 75, 79, 81
NISS026BKP	73, 75, 79, 81
NISS026B	72, 74, 78, 80
NISS027B	72, 75, 78, 80
NISS034B	84
NISS035B	84
NISS036CKF	77
NISS036CKG	77
NISS036DKF	77
NISS036DKG	77
NISS037BKF	79
NISS037BKG	79
NISS037BKP	79
NISS037CKF	79, 81
NISS037CKG	79, 81
NISS037CKP	79, 81
NISS037DKF	79, 81
NISS037DKG	79, 81
NISS037DKP	79, 81
NISS038B	94
NISS039B	94
NISS040B	85, 89, 91, 93
NISS040C	85, 86, 89, 90, 91, 93
NISS040D	86, 90
NISS041BKF1	90
NISS041BKF	89
NISS041BKG1	90
NISS041BKG	89
NISS041BKP1	90
NISS041BKP	89

Part No.	Page
NISS041B	89, 90
NISS041CKF1	90
NISS041CKF	89
NISS041CKG1	90
NISS041CKG	89
NISS041CKP1	90
NISS041CKP	89
NISS041C	89, 90
NISS041DKF1	90
NISS041DKF	89
NISS041DKG1	90
NISS041DKG	89
NISS041DKP1	90
NISS041DKP	89
NISS041D	89, 90
NISS042BKF1	86
NISS042BKF	85
NISS042BKG1	86
NISS042BKG	85
NISS042B	85, 86
NISS042CKF1	86
NISS042CKF	85
NISS042CKG1	86
NISS042CKG	85
NISS042C	85, 86
NISS043BKF1L	81
NISS043BKF1	81
NISS043BKFL	73, 75, 79, 81
NISS043BKF	73, 75, 79, 81
NISS043BKP1L	81
NISS043BKP1	81
NISS043BKPL	73, 75, 79, 81
NISS043BKP	73, 75, 79, 81
NISS043B	72, 74, 78, 80, 72, 75, 78, 80
NISS045AKF	82
NISS045AKG	82
NISS045AKP	82
NISS045A	82
NISS045BKF	82
NISS045BKG	82
NISS045BKP	82
NISS045B	82
NISS045CKF	82
NISS045CKG	82
NISS045CKP	82
NISS045C	82
NISS046A	82
NISS046B	82
NISS046C	82
NISS047BKF	93
NISS047BKG	93
NISS047BKP	93
NISS047B	93
NISS048	92
NISS049BKG	92
NISS049B	92
NISS057BKF	91



Part No.	Page
NISS057BKG	91
NISS057BKP	91
NISS057B	91
NISS057CKF	91
NISS057CKG	91
NISS057CKP	91
NISS057C	91
NISS057DKF	91
NISS057DKG	91
NISS057DKP	91
PANHARD001	134, 138
PANHARD002	135, 139
PANHARD003	72, 74, 77, 78, 80
PANHARD004	73, 75, 79, 81
PANHARD005	80
PANHARD006	81
PANHARD007	134, 138
PANHARD008	72, 74, 77, 78, 80
PANHARD009	80
PANHARD010	35
PANHARD011	35
PANHARD013	125, 127, 128, 130, 132
PATF15	72, 74, 77, 78, 80
PATF30	72, 74, 77, 78, 80
PATR15	73, 75, 79, 81
PATR30	73, 75, 79, 81
REN001BKG	18, 95
REN001B	18, 95
REN002B	18, 95
SBEXT001	125, 127, 128, 130, 132, 134, 138
SBEXT002	135, 139
SBEXT003	72, 73, 74, 75, 78, 79, 80, 81
SBEXT004	79, 81
SBEXT005	135, 139
SBEXT006	72, 73, 74, 75, 77, 78, 79, 80, 81, 110, 142, 143, 144
SBEXT007	79, 81
SBEXT008	35
SSANG001	96
SSANG002BKF	96
SSANG002BKG	96
SSANG002B	96
SUB001B	103
SUB002B	103
SUB003B	103
SUB004B	103
SUZ001BD/S	97
SUZ001BKG	97
SUZ001BN/S	97
SUZ002BD/S	97
SUZ002B	97
SUZ003BKG	100
SUZ003B	100
SUZ004B	100
SUZ005BKG	100
SUZ005B	100, 101

Part No.	Page
SUZ006B	100
SUZ007B	98
SUZ008B	98
SUZ009BKG	99
SUZ009B	99
SUZ010B	99
SUZ011B	99
SUZ013BKG	101
SUZ013B	101
SUZ015B	101
SUZ016BKG	101
SUZ016B	101
SUZ017B	101
SUZ018BKG	101
SUZ018B	101
SUZ019AKG	102
SUZ019BKG	102
SUZ019B	102
SUZ019C	102
SUZ020A	102
SUZ020B	102
TOY001BKF	114
TOY001BKG	114
TOY001BKP	114
TOY001B	114, 116
TOY002B	114
TOY003BKF	116
TOY003BKG	116
TOY003BKP	116
TOY003C	116
TOY004BKF	115
TOY004BKG	115
TOY004BKP	115
TOY004B	115, 117
TOY004C	115, 117
TOY005BKF	117
TOY005BKG	117
TOY005BKP	117
TOY005C	117
TOY006AKF1	119
TOY006AKF2	121
TOY006AKF3	121
TOY006AKF	119
TOY006AKG1	119
TOY006AKG2	121
TOY006AKG3	121
TOY006AKG	119
TOY006AKP1	119
TOY006AKP2	121
TOY006AKP3	121
TOY006AKP	119
TOY006BKF1	119
TOY006BKF2	121
TOY006BKG1	119
TOY006BKG2	121
TOY006BKP1	119
TOY006BKP2	121

Part No.	Page
TOY006B	118, 120
TOY006CKF1	119
TOY006CKF2	121
TOY006CKG1	119
TOY006CKG2	121
TOY006CKP1	119
TOY006CKP2	121
TOY006C	118, 120
TOY006D	118, 120
TOY007AD/S	118, 120, 125
TOY007AN/S	118, 120, 122
TOY007BD/S	118, 120, 125
TOY007BKF1	119
TOY007BKF2	121
TOY007BKG1	119
TOY007BKG2	121
TOY007BKP1	119
TOY007BKP2	121
TOY007BN/S	118, 120, 122
TOY007CD/S	118, 120, 125
TOY007CKF1	119
TOY007CKF2	121
TOY007CKG1	119
TOY007CKG2	121
TOY007CKP1	119
TOY007CKP2	121
TOY007CN/S	118, 120
TOY008BKF	126
TOY008BKG	126
TOY008BKP	126
TOY008B	122, 126
TOY008CKF	126
TOY008CKG	126
TOY008CKP	126
TOY008C	126
TOY009B	126
TOY009C	126
TOY009DKF	126
TOY009DKG	126
TOY009DKP	126
TOY009D	126
TOY009EKF	126
TOY009EKG	126
TOY009EKP	126
TOY009E	126
TOY010BD/S	104, 105
TOY010BKF1	104
TOY010BKF2	105
TOY010BKG1	104
TOY010BKG2	105
TOY010BN/S	104, 105
TOY010CD/S	104, 105
TOY010CKF1	104
TOY010CKF2	105
TOY010CKG1	104
TOY010CKG2	105
TOY010CN/S	104, 105

Part No.	Page
TOY011BKF	107
TOY011BKG	107
TOY011B	104, 105, 107
TOY011CKF	107
TOY011CKG	107
TOY011C	104, 105, 107
TOY012CKF1L	135, 139
TOY012CKF1	135, 139
TOY012CKF2L	135, 139
TOY012CKF2	135, 139
TOY012CKP1L	135, 139
TOY012CKP1	135, 139
TOY012CKP2L	135, 139
TOY012CKP2	135, 139
TOY012C	134, 138
TOY013B	137, 134, 138
TOY013C	134, 138
TOY013D	134, 138
TOY016AKF	122
TOY016AKG	122
TOY016AKP	122
TOY016BKF	122
TOY016BKG	122
TOY016BKP	122
TOY017AKF	145
TOY017AKG	145
TOY017AKP	145
TOY017A	145
TOY017BKF	145
TOY017BKG	145
TOY017BKP	145
TOY017B	145
TOY017SKF	145
TOY017SKG	145
TOY017SKP	145
TOY017S	145
TOY018BKF	123
TOY018BKG	123
TOY018B	123
TOY019B	123
TOY023BKF	108
TOY023BKG	108
TOY023B	108
TOY023CKF	108
TOY023CKG	108
TOY023C	108
TOY024BKF	135, 139
TOY024BKG	135, 139
TOY024BKP	135, 139
TOY024B	134, 138
TOY024C	134, 138
TOY025B	134, 138
TOY025C	134, 137, 138
TOY025D	134, 138
TOY026	106, 107, 108
TOY027AKF	106
TOY027AKG	106



PRODUCT CODE

PRODUCT QUICK REFERENCE

Part No.	Page
TOY027A	106
TOY027BKF	106
TOY027BKG	106
TOY027B	106
TOY027CKF	106
TOY027CKG	106
TOY027C	106
TOY034B	115
TOY038AKF1	141
TOY038AKF	109, 141
TOY038AKG1	141
TOY038AKG	109, 141
TOY038AKP1	141
TOY038AKP	109, 141
TOY038BKF1	109, 141
TOY038BKF	109, 141
TOY038BKG1	109, 141
TOY038BKG	109, 141
TOY038BKP1	109, 141
TOY038BKP	109, 141
TOY038B	109, 141, 145
TOY038CKF1	141
TOY038CKF	141
TOY038CKG1	141
TOY038CKG	141
TOY038CKP1	141
TOY038CKP	141
TOY038C	109, 141
TOY039A	109, 141
TOY039B	109, 141
TOY039C	109, 141
TOY046AKF1	131
TOY046AKF	129
TOY046AKG1	131
TOY046AKG	129
TOY046AKP1	131
TOY046AKP	129
TOY046A	125, 127, 128, 130, 132
TOY046BKF1	131, 133
TOY046BKF	129
TOY046BKG1	131
TOY046BKG	133, 129
TOY046BKP1	131, 133
TOY046BKP	129
TOY046B	125, 127, 128, 130, 132
TOY046CKF1	131, 133
TOY046CKF	129
TOY046CKG1	131, 133
TOY046CKG	129
TOY046CKP1	131, 133
TOY046CKP	129
TOY046C	125, 127, 128, 130, 132
TOY046DKF1	131, 133
TOY046DKF	129
TOY046DKG1	131, 133
TOY046DKG	129
TOY046DKP1	131, 133
TOY046DKP	129

Part No.	Page
TOY046EKF1	131, 133
TOY046EKF	129
TOY046EKP1	131, 133
TOY046EKP	129
TOY047A	128, 130
TOY047B	128, 130, 132
TOY047CKFGVM1	129, 131, 133
TOY047CKFGVM	129, 131, 133
TOY047C	128, 130, 132
TOY047DKFGVM1	129, 131, 133
TOY047DKFGVM	129, 131, 133
TOY047D	128, 130, 132
TOY047E	128, 130, 132
TOY048BKF	124
TOY048BKG	124
TOY048B	124
TOY048CKF	124
TOY048CKG	124
TOY048C	124
TOY049B	124
TOY049C	124
TOY050BKF	137
TOY050BKG	137
TOY050BKP	137
TOY050CKF	137
TOY050CKG	137
TOY050CKP	137
TOY050	137
TOY051BKF	137
TOY051BKG	137
TOY051BKP	137
TOY051CKF	137
TOY051CKG	137
TOY051CKP	137
TOY051	137
TOY055AKF1	142
TOY055AKF	110, 142, 144
TOY055AKG1	142
TOY055AKG	110, 142, 144
TOY055AKP1	142
TOY055AKP	110, 142, 144
TOY055A	110, 112, 142, 144, 145
TOY055BKF1	142
TOY055BKF	110, 142, 144
TOY055BKG1	142
TOY055BKG	110, 142, 144
TOY055BKP1	142, 110, 142, 144
TOY055B	110, 112, 142, 144, 145
TOY055CKF1	142
TOY055CKF	110, 142, 144
TOY055CKG1	142
TOY055CKG	110, 142, 144
TOY055CKP1	142
TOY055CKP	110, 142, 144
TOY055C	110, 112, 142, 144
TOY056A	110, 142, 143, 144
TOY056B	110, 142, 143, 144
TOY056C	110, 142, 143, 144

Part No.	Page
TOY057AKF	113
TOY057AKG	113
TOY057AKP	113
TOY057A	112
TOY057BKF	113
TOY057BKG	113
TOY057BKP	113
TOY057B	112
TOY057CKFGVM1	113
TOY057CKFGVM	113
TOY057CKF	113
TOY057CKG	113
TOY057CKP	113
TOY057C	112
TOY057DKFGVM1	113
TOY057DKFGVM	113
TOY057DKF	113
TOY057DKG	113
TOY057DKP	113
TOY057D	112
TOY058AKF	125
TOY058AKG	125
TOY058AKP	125
TOY058BKF	125
TOY058BKG	125
TOY058BKP	125
TOY058CKF	125
TOY058CKG	125
TOY058CKP	125
TOY060B	134, 138
TOY061B	134, 138
TOY061C	134, 138
TOY062BKF	127
TOY062BKG	127
TOY062BKP	127
TOY062B	127
TOY062CKF	127
TOY062CKG	127
TOY062CKP	127
TOY062C	127
TOY062DKF	127
TOY062DKG	127
TOY062DKP	127
TOY062D	127
TOY063AKF	140
TOY063AKG	140
TOY063AKP	140
TOY063A	140
TOY063BKF1L	135, 139
TOY063BKF1	135, 139
TOY063BKF2L	135, 139
TOY063BKF2	135, 139
TOY063BKF	140
TOY063BKG	140
TOY063BKP1L	135, 139
TOY063BKP1	135, 139
TOY063BKP2L	135, 139
TOY063BKP2	135, 139

Part No.	Page
TOY063BKP	140
TOY063B	140
TOY063CKF	140
TOY063CKG	140
TOY063CKP	140
TOY063C	140
TOY064A	140
TOY064B	140
TOY064C	140
TOY064EA	140
TOY065AKF1	143
TOY065AKF	143
TOY065AKG1	143
TOY065AKG	143
TOY065AKP1	143
TOY065AKP	143
TOY065BKF1	143
TOY065BKF	143
TOY065BKG1	143
TOY065BKG	143
TOY065BKP1	143
TOY065BKP	143
TOY065B	143, 146
TOY065CKF1	143
TOY065CKF	143
TOY065CKG1	143
TOY065CKG	143
TOY065CKP1	143
TOY065CKP	143
TOY065C	143, 146
TOY066BD/S	146
TOY066BKF	146
TOY066BKG	146
TOY066BKP	146
TOY066BN/S	146
TOY067B	111
TOY068BKG	111
TOY068B	111
TOY070BKF	147
TOY070BKP	147
TOY070B	147
TOY070C	147
TOY071B	147
TR0L001BKG	148
TR0L001B	148
TR0L002B	148
TR0L003BKG	149
TR0L003B	149
TR0L004B	149
UTA001	135, 139
UTA003	73, 75, 79, 81
VOLKS001BKG	152
VOLKS001B	152
VOLKS001CKG	152
VOLKS001C	152
VOLKS002B	152
VOLKS002C	152



1. Interpretation

In these Terms and Conditions of Sale ("Terms"), "Goods" means the Goods the subject of the Contract; IRONMAN 4X4 Pty. Ltd." means the entity selling the Goods; "Buyer" means the entity purchasing the Goods; "Contract" means each contract between IRONMAN 4X4 Pty. Ltd. and the Buyer for the sale and purchase of the Goods and "order" includes "offer".

2. Terms and Conditions

The only Terms of the Contract are those agreed to in writing by IRONMAN 4X4 Pty. Ltd. These Terms (to the extent they are not inconsistent with Terms agreed to in writing by IRONMAN 4X4 Pty. Ltd.) and those which are implied or imposed by law (including the Trade Practices Act 1974)) to the extent that it is not lawful or possible to exclude them. All other Terms, Conditions and Warranties are expressly excluded. If a conflict arises between the Terms of any order made by the Buyer and these Terms, these Terms will prevail. An agreement to deliver the Goods in instalments is taken to be a separate Contract for each instalment. These Terms and each Contract including them are governed by the laws of New South Wales, and IRONMAN 4X4 Pty. Ltd. and the Buyer submit to the jurisdiction of the courts of that State. If a Term is held to be unenforceable, the remaining Terms will apply.

3. Quotations and Orders

Any quotation made by IRONMAN 4X4 Pty. Ltd. will not be construed or operate as an offer or obligation to sell. IRONMAN 4X4 Pty. Ltd. reserves the right to accept or reject in its absolute discretion any order received by it. The Buyer will not be entitled to cancel or refuse delivery of, or payment for, any order made by it which has been accepted by IRONMAN 4X4 Pty. Ltd.

4. Price

The price payable to IRONMAN 4X4 Pty. Ltd. by the Buyer for the Goods will be the price agreed; failing which it will be the price prevailing at the date the Goods are dispatched by IRONMAN 4X4 Pty. Ltd. for delivery to the Buyer. Prices are payable in Australian currency and exclusive of delivery costs, taxes, duties and other imposts which, if changeable, are payable by the Buyer. Prices quoted in any IRONMAN 4X4 Pty. Ltd. Price List are suggested prices only and may be changed by IRONMAN 4X4 Pty. Ltd. without notice.

5. Payment

The Buyer must pay cash for the Goods on delivery or, at IRONMAN 4X4 Pty. Ltd.'s absolute discretion, strictly within 30 days of delivery. IRONMAN 4X4 Pty. Ltd. will appropriate payments first to outstanding interest and then to outstanding accounts in the date order rendered.

6. Overdue Amounts

If Buyer fails to pay all or part of any amount to IRONMAN 4X4 Pty. Ltd. when due, interest will be payable on that amount from its due date until it is paid in full at a rate equivalent to 2% per annum above the overdraft rate from time to time charged to IRONMAN 4X4 Pty. Ltd. by its principal banker.

7. Delivery

IRONMAN 4X4 Pty. Ltd. will make all reasonable efforts to deliver the Goods on the dates agreed, to the place or carrier designated by the Buyer. IRONMAN 4X4 Pty. Ltd. has the right to make delivery in instalments and to deliver those Goods available for delivery. The Buyer has no right to terminate the Contract because of a delay in delivery.

8. Warranty

IRONMAN 4X4 Pty. Ltd. warrants that its products are manufactured to S.A.E. - Society of Automotive Engineers - specifications for the particular product. IRONMAN 4X4 Pty. Ltd. further warrants that all products sold hereunder are free from defects in material and workmanship.

IRONMAN 4X4 Pty. Ltd. will, at its sole option, repair or replace any products supplied by it which are found to be defective in either materials or workmanship providing that IRONMAN 4X4 Pty. Ltd. is actually notified in writing from the Buyer of the alleged defect within ninety (90) days from the date of invoice. Any claim not made within this period shall conclusively be deemed waived by the Buyer. Repair or replacement is preconditioned on the examination of the Goods by IRONMAN 4X4 Pty. Ltd. and, if requested by IRONMAN 4X4 Pty. Ltd. return of the Goods to IRONMAN 4X4 Pty. Ltd.

No products are to be returned to IRONMAN 4X4 Pty. Ltd. without its written consent, according to procedures outlined in this manual, and the receipt by the Buyer of specific shipping instructions. IRONMAN 4X4 Pty. Ltd. shall not be liable for any expense incurred by the Buyer in order to remedy any defect in its products. IRONMAN 4X4 Pty. Ltd. shall not be liable for any consequential, special, indirect or contingent damage, or expense arising directly or indirectly from any defect in its products or from use of any products. This warranty does not apply to (1) Goods bought for industrial, mining or agricultural use, (2) Goods bought for resupply or resale, (3) Goods no longer required by the Buyer, (4) Goods incorrectly chosen by the Buyer; or (5) Goods modified or altered by the Buyer (including changing colour).

EXCEPT AS SET FORTH HEREIN, AND EXCEPT AS TO TITLE, IT IS EXPRESSLY AGREED (a) THAT THERE IS NO WARRANTY OR MERCHANTABILITY OR FITNESS FOR A PARTICULAR PURPOSE, NOR OTHER WARRANTY EXPRESS, IMPLIED OR STATUTORY NOR ANY AFFIRMATION OF FACT, OR PROMISES BY IRONMAN 4X4 PTY. LTD. WITH REFERENCE TO THE GOODS WHICH EXTENDS BEYOND THE SPECIFICATIONS, AGREED UPON BY IRONMAN 4X4 PTY. LTD. AND THE BUYER AND (b) THAT THE BUYER IF ANY, MUTUALLY ACKNOWLEDGES THAT IT IS PURCHASING THE GOODS SOLELY ON THE BASIS OF THE COMMITMENTS OF IRONMAN 4X4 PTY. LTD. EXPRESSLY SET FORTH HEREIN. NO PERSON IS AUTHORISED TO CHANGE OR ADD TO ANY OF IRONMAN 4X4 PTY. LTD.'S OBLIGATIONS UNDER THIS WARRANTY. IN NO EVENT SHALL IRONMAN 4X4 PTY. LTD. BE LIABLE FOR ANTICIPATED PROFITS OR FOR INCIDENTAL OR CONSEQUENTIAL DAMAGES.

The Buyer agrees to indemnify and hold IRONMAN 4X4 Pty. Ltd. harmless from and against any loss, injury or damage, to person or property, that extends beyond the warranties set forth above, whether the claims against IRONMAN 4X4 Pty. Ltd. or the damages are incidental or consequential.

Accessories / Mining Accessories / Steel Tray (Excluding Winches and ROPS) - 1 Year Warranty.

Winches and ROPS - 3 Years Warranty.

Suspension - 3 Year 60,000km Warranty.

Ironman 4x4 warrants the original buyer, only when purchased new via authorised Ironman 4x4 resellers and distributors, from date of sale.

Product is warranted against defects in material or workmanship that cause the product to perform below the specified limits set by Ironman 4x4, to the extent that Ironman 4x4 will repair or replace any parts which are found to be defective.

All warranty claims must be submitted via original purchasing store or chain, unless otherwise arranged.

Proof of original purchase must be presented upon request.

Products may require to be returned to Ironman 4x4 for assessment or repair. Postage and removal costs involved are not the responsibility of Ironman 4x4, and may only be considered upon discretion by Ironman 4x4 in the event of such claim being verified.

The warranty does NOT apply where, 1) acts of neglect or misuse are evident, 2) product has been modified, 3) vehicles which are modified or not the recommended vehicle of use, 4) used in racing or competition conditions without the prior consent of Ironman 4x4, 5) used beyond the expectations of the original vehicle manufacturer.

Before installation of any product, please ensure you have received the correct parts for your application.

Ordering of the correct parts is the responsibility of the Buyer. Return of a product in an unused condition will attract a 15% restock fee, where Ironman 4x4 is not at fault.

Return of used or soiled product, 1) outside warranty period, 2) without fault, will result in refusal of your claim and be returned at the Buyer's expense.

Damage to products through fitment error is not covered under warranty.



9. Damage

The Buyer acknowledges that the Goods leaving IRONMAN 4X4 Pty. Ltd's premises are adequately packed. Claims for damage in transit must be made against the carrier and, while IRONMAN 4X4 Pty. Ltd. will not accept liability for any damage, details of any claim must be promptly advised to IRONMAN 4X4 Pty. Ltd. Prior to acknowledging delivery to the carrier, the Buyer must ensure that the complete consignment has been received as specified in the carrier's note. Any shortage or visible damage to outer packaging must be endorsed on the carrier's note. Any shortages and/or damages must be reported to IRONMAN 4X4 Pty. Ltd. within 72 hours or receipt.

10. Title

10.1 Title to the Goods will not pass to the Buyer until the earlier of:

- (a) IRONMAN 4X4 Pty. Ltd. being paid in full under all Contracts; or
- (b) the sale by the Buyer of the Goods in its ordinary course of business (in which case the Buyer must keep an accurate account of each sale, hold the proceeds of each sale separate from the Buyer's own money and pay IRONMAN 4X4 Pty. Ltd. in full from the proceeds of the purchase price of each sale, despite that the payment is not otherwise due).

10.2 Until title to the Goods passes to the Buyer, the Buyer must:

- (a) hold the Goods as bailed for IRONMAN 4X4 Pty. Ltd. and keep them in good order and condition;
- (b) not remove any markings placed by IRONMAN 4X4 Pty. Ltd. and ensure that the Goods can be readily identified and distinguished from other property in the Buyer's possession; and
- (c) deliver the Goods to IRONMAN 4X4 Pty. Ltd. immediately upon demand and, for this purpose, IRONMAN 4X4 Pty. Ltd. is authorised to enter at any time any premises on which the Goods may be located (the costs incidental to which will be borne by the Buyer).

11. Risk

Risk in the Goods (including insurance responsibility) passes to the Buyer on delivery of the Goods to the place or carrier designated by the Buyer or, if sooner, possession of the Goods passes to the Buyer or its agent.

12. Implied Terms, Limitation of Liability and Buyers Indemnity

12.1 Subject to Clause 2, IRONMAN 4X4 Pty. Ltd's liability for any breach of a condition or warranty imposed or implied by law in respect of any Goods or services which are not of a kind ordinarily acquired for personal, domestic or household use or consumption (provided that this provision does not apply if the Buyer establishes that it is not fair or reasonable for IRONMAN 4X4 Pty. Ltd. to rely on it) will be limited to:

- (a) in the case of Goods supplied, any one or more of the following (as IRONMAN 4X4 Pty. Ltd. may determine):
 - (i) replacement of the Goods or the supply of equivalent goods;
 - (ii) repair of the Goods;
 - (iii) payment of the cost of replacing the Goods or of acquiring or obtaining equivalent goods; or
 - (iv) payment of the cost of having the Goods repaired; and
- (b) in the case of services supplied, any one of the following (as IRONMAN 4X4 Pty. Ltd. may determine):
 - (i) supplying the services again; or
 - (ii) payment of the costs of having the services supplied again.

12.2 Subject to these Terms, IRONMAN 4X4 Pty. Ltd. will not be liable for any loss, damage, expense or injury of any kind or nature suffered or incurred by the Buyer or any other person, arising out of or in connection with, the Contract (including, without limitation, liability due to negligence or wilful default of IRONMAN 4X4 Pty. Ltd. and any delay in delivery) or any error (whether negligent or not) in information supplied to the Buyer in connection with its subject matter or the use, possession or delivery of the Goods or the exercise by IRONMAN 4X4 Pty. Ltd. of its rights under Clause 16 and the Buyer will indemnify IRONMAN 4X4 Pty. Ltd. in relation to any such loss, damage, expense or injury.

13. Claims

Any claim made by the Buyer must be in writing and contain the particulars specified in the IRONMAN 4X4 Pty. Ltd's 'Application for Exchange or Credit' or 'Applications for Warranty' and be received by IRONMAN 4X4 Pty. Ltd. within 14 days after delivery of the Goods. Subject to the Contract, no claim for credit will be recognised where (1) the Goods are made to special order or the Buyer's specifications or drawings, (2) are no longer required by the Buyer, (3) are returned without the particulars required by this Clause, (4) the Buyer has modified or altered the Goods (including changing colour) or (5) if the IRONMAN 4X4 Pty. Ltd. Catalogue stipulates that return will not be accepted. If the Buyer insists on returning the Goods, it must pay IRONMAN 4X4 Pty. Ltd. a handling fee equal to 40% of the price of the Goods.

14. Force Majeure

Despite any other Term or condition of the Contract, IRONMAN 4X4 Pty. Ltd. will not be liable for any loss, damage, expense or injury of any kind or nature suffered or incurred by the Buyer or any other person, arising out of or in connection with any delay in delivery, or failure to perform any other term or condition of the Contract where that delay or failure is caused by an act of God, fire, labour dispute, civil commotion, intervention of a Government, inability to obtain labour, materials or manufacturing facilities, accidents, interruptions of or delay in transportation or any other cause beyond IRONMAN 4X4 Pty. Ltd's reasonable control

15. Errors or Omissions

IRONMAN 4X4 Pty. Ltd. has the right to correct any clerical errors or omissions, whether in computation or otherwise in any quotation, acknowledgment or document forming part of a Contract.

16. Breach by Buyer

If the Buyer breaches a Contract or IRONMAN 4X4 Pty. Ltd. is not satisfied of a Buyer's ability to pay or otherwise comply with each Contract, IRONMAN 4X4 Pty. Ltd. may by notice to the Buyer, but without compensation, terminate every Contract, suspend or cease deliveries under all Contracts, set-off all deposits against amounts due and made all amounts then outstanding by the Buyer to IRONMAN 4X4 Pty. Ltd. immediately due and payable.

17. Waiver

IRONMAN 4X4 Pty. Ltd's right under the Contract are cumulative and in addition to any other rights. No delay or failure by IRONMAN 4X4 Pty. Ltd. to enforce any right is a waiver of that right. Any waiver by IRONMAN 4X4 Pty. Ltd. of any term or breach of the Contract is not to be taken as a continuing waiver or a waiver of any subsequent breach.



IRONMAN

4 X 4



www.ironman4x4.com



Find us on Facebook
facebook.com/Ironman4x4au

VOLUME 15